

User's Guide



Fireface UFX

The most powerful FireWire® and USB audio interface ever!

24 Bit / 192 kHz ✓

TotalMix™



SyncAlign™

ZLM™

SyncCheck™



SteadyClock™



USB 2.0 / FireWire 400 Digital I/O System
12 + 16 + 2 Channels Analog / ADAT / AES Interface
24 Bit / 192 kHz Digital Audio
60 x 30 Matrix Router
2 x MIDI I/O
Full Stand-Alone Operation
Class Compliant Operation
MIDI Remote Control

▶	Important Safety Instructions	6
---	--	---

▶ **General**

1	Introduction	8
2	Package Contents	8
3	System Requirements	8
4	Brief Description and Characteristics	8
5	First Usage - Quick Start	
5.1	Connectors – Controls - Display	9
5.2	Quick Start	11

▶ **Installation and Operation - Windows**

6	Hardware, Driver and Firmware Installation	
6.1	Hardware and Driver Installation.....	14
6.2	De-installing the Drivers.....	14
6.3	Firmware Update.....	14
7	Configuring the Fireface	
7.1	Settings Dialog – General	15
7.2	Settings Dialog – Pitch	17
8	Operation and Usage	
8.1	Playback.....	18
8.2	DVD Playback (AC-3 / DTS)	19
8.3	Notes on WDM.....	20
8.4	Channel Count under WDM.....	21
8.5	Multi-client Operation	21
8.6	Analog Recording.....	22
8.7	Digital Recording.....	22
8.8	Clock Modes - Synchronization	23
9	Operation under ASIO	
9.1	General	24
9.2	Channel Count under ASIO	24
9.3	Known Problems	25
10	Using more than one Fireface UFX	25
11	DIGICheck Windows	26
12	Hotline – Troubleshooting	27

▶ Installation and Operation - Mac OS X

13	Hardware, Driver and Firmware Installation	
13.1	Hardware and Driver Installation	30
13.2	De-installing the Drivers.....	30
13.3	Firmware Update	31
14	Configuring the Fireface	
14.1	Settings Dialog.....	32
14.2	Clock Modes - Synchronization	33
15	Mac OS X FAQ	
15.1	MIDI doesn't work	34
15.2	Repairing Disk Permissions.....	34
15.3	Supported Sample Rates.....	34
15.4	Channel Count under Core Audio	34
15.5	Various Information.....	35
16	Using more than one Fireface	35
17	DIGICheck Mac	36
18	Hotline – Troubleshooting	37

▶ Inputs and Outputs

19	Analog Inputs	
19.1	Line Rear	40
19.2	Microphone / Line / Inst Front.....	40
20	Analog Outputs	
20.1	Line	41
20.2	Phones / Line Out	41
21	Digital Connections	
21.1	ADAT	42
21.2	AES	42
21.3	MIDI	43
22	Word Clock	
22.1	Word Clock Input and Output	44
22.2	Technical Description and Background	45
22.3	Cables and Termination.....	46
22.4	General Operation	46

▶ Stand-Alone Operation

23	Operation and Usage	
23.1	General	48
23.2	Settings at the Unit.....	48
23.3	Store / Load Setups at the Unit.....	48
23.4	Storing Setups from the Computer	48
24	Examples	
24.1	12-Channel AD/DA-Converter	49
24.2	4-Channel Mic Preamp	49
24.3	Monitor Mixer	49
24.4	Digital Format Converter.....	49
24.5	Analog/Digital Routing Matrix	49
24.6	Stand-Alone Recorder/Player	49

▶ **TotalMix FX**

25	Routing and Monitoring	
25.1	Overview	52
25.2	The User Interface	54
25.3	The Channel.....	55
25.3.1	Settings	57
25.3.2	Equalizer	58
25.3.3	Dynamics	60
25.4	Section Control Room.....	61
25.5	The Control Strip.....	62
25.5.1	View Options	63
25.5.2	Snapshots - Groups	64
25.5.3	Channel Layout – Layout Presets.....	64
25.5.4	Scroll Location Markers	66
25.6	Reverb and Echo	67
25.7	Preferences.....	70
25.7.1	Store for Current or All Users (Windows)	71
25.8	Settings	72
25.8.1	Mixer Page	72
25.8.2	MIDI Page	73
25.8.3	OSC Page	74
25.8.4	Aux Devices	75
25.9	Hotkeys and Usage.....	76
25.10	Menu Options.....	77
25.11	Menu Window	78
26	The Matrix	
26.1	Overview	78
26.2	Elements of the Matrix View	78
26.3	Usage.....	79
27	Tips and Tricks	
27.1	ASIO Direct Monitoring (Windows).....	79
27.2	Copy a Submix.....	79
27.3	Doubling the Output Signal (Mirror).....	79
27.4	Delete a Submix.....	80
27.5	Copy and Paste everywhere.....	80
27.6	Recording a Submix - Loopback.....	80
27.7	MS Processing	82
28	MIDI Remote Control	
28.1	Overview	83
28.2	Mapping	83
28.3	Setup.....	84
28.4	Operation	84
28.5	Simple MIDI Control	85
28.6	Stand-Alone MIDI Control	86
28.7	Loopback Detection	88
28.8	OSC (Open Sound Control).....	88

▶ Class Compliant Mode

29	General	90
30	System Requirements	90
31	Operation	91
	31.1 Useful Hints.....	91
	31.2 Class Compliant under Windows/Mac OS X	93
32	Supported Inputs and Outputs	94
33	Operation at the Unit	94
34	Audio Routing and Processing	94
35	Setups	95

▶ DUREC - Direct USB Recording

36	Direct USB Recording	
	36.1 Overview	98
	36.2 Operation	98
	36.3 Limitations and Important Notes	99
	36.4 Multichannel WAV File Batch Processor	101
	36.5 Technical Background	102

▶ Technical Reference

37	Technical Specifications	
	37.1 Analog	104
	37.2 MIDI	105
	37.3 Digital	105
	37.4 Digital Inputs	106
	37.5 Digital Outputs	107
	37.6 General	107
38	Technical Background	
	38.1 Lock and SyncCheck	108
	38.2 Latency and Monitoring	109
	38.3 USB Audio	110
	38.4 FireWire Audio	111
	38.5 DS – Double Speed	112
	38.6 QS – Quad Speed	112
	38.7 Noise Level in DS / QS Mode	113
	38.8 SteadyClock	113
39	Diagrams	
	39.1 Block Diagram Fireface UFX	114
	39.2 Connector Pinouts	115

▶ Miscellaneous

40	Accessories	118
41	Warranty	118
42	Appendix	119
43	Declaration of Conformity	120

Important Safety Instructions



ATTENTION! Do not open chassis – risk of electric shock

The unit has non-isolated live parts inside. No user serviceable parts inside. Refer service to qualified service personnel.



Mains

- The device must be earthed – never use it without proper grounding
- Do not use defective power cords
- Operation of the device is limited to the manual
- Use same type of fuse only



To reduce the risk of fire or electric shock do not expose this device to rain or moisture. Prevent moisture and water from entering the device. Never leave a pot with liquid on top of the device. Do not use this product near water, i. e. swimming pool, bathtub or wet basement. Danger of condensation inside – don't turn on before the device has reached room temperature.



Installation

Surface may become hot during operation – ensure sufficient ventilation. Avoid direct sun light and do not place it near other sources of heat, like radiators or stoves. When mounting in a rack, leave some space between this device and others for ventilation.



Unauthorized servicing/repair voids warranty. Only use accessories specified by the manufacturer.



Read the manual completely. It includes all information necessary to use and operate this device.

User's Guide



Fireface UFX

▶ General

1. Introduction

Thank you for choosing the Fireface UFX. This unique audio system is capable of transferring analog and digital audio data directly to a computer from practically any device. The latest Plug and Play technology guarantees a simple installation, even for the inexperienced user. The numerous unique features and well thought-out configuration dialog puts the Fireface UFX at the very top of the range of computer-based audio interfaces.

The package contains drivers for Windows XP / Vista / 7 / 8 / 10 and Mac OS X x86 (Intel).

Our high-performance philosophy guarantees maximum system performance by executing as many functions as possible not in the driver (i.e. the CPU), but within the audio hardware.

2. Package Contents

- Fireface UFX
- Cable USB 2.0, 1.8 m (6 ft)
- RME Driver CD
- Cable IEEE1394a (FW400), 4 m (13 ft)
- Power cord
- Manual
- 1 optical cable (TOSLINK), 2 m (6.6 ft)

3. System Requirements

- Windows XP SP2 or up, Intel Mac OS X (10.6 or up)
- 1 x OHCI compatible FireWire Port 400 (1394a), FireWire 800 (1394b) via cable adapter or
- 1 x USB 2.0 port or USB 3.0 port
- For USB: Computer with at least Pentium Core 2 Duo CPU

4. Brief Description and Characteristics

- All settings can be changed in real-time
- Buffer sizes/latencies from 48 up to 8192 samples selectable
- 8 channels 96 kHz/24 bit Record/Playback via ADAT optical (S/MUX)
- Clock modes slave and master
- Automatic and intelligent master/slave clock control
- Unsurpassed Bitclock PLL (audio synchronization) in ADAT mode
- SteadyClock: Jitter-immune, super-stable digital clock
- DDS technology for free setting of the sample rate
- SyncAlign guarantees sample aligned and never swapping channels
- SyncCheck tests and reports the synchronization status of input signals
- TotalMix for latency-free submixes and perfect ASIO Direct Monitoring
- TotalMix: 1800 channel mixer with 46 bit internal resolution
- TotalMix FX: 3-band EQ, Low Cut, Reverb, Echo, Compressor, Expander, Auto Level
- 2 x MIDI I/O, 32 channels high-speed Low-Jitter MIDI
- 2 x Hi-power headphone output
- DIGICheck DSP: Level meter in hardware, peak- and RMS calculation

5. First Usage – Quick Start

5.1 Connectors – Controls – Display

The front of the Fireface UFX features four instrument and microphone inputs, two stereo headphone outputs, three rotary encoders with push functionality, a graphical colour display, and several status LEDs.

The Neutrik combo sockets of the four **Mic/Line** inputs provide XLR and 6.3 mm / 1/4" TRS connection. They have LEDs for Signal (SIG), Phantom power (48V) and activated TRS input. The latter is high impedance and can be used as instrument input as well.



The analog outputs 9 to 12 feed the headphones outputs **Phones 1** and **Phones 2**. These low impedance outputs of highest quality are able to drive headphones at higher levels undistorted, no matter if low or high impedance headphones are used.

MIDI 2 I/O. Two 5-pin DIN connectors provide the second MIDI input and output.

Memory. Connector for USB stick or USB hard drive. Offers direct Recording / Playback from the device (DSP firmware 138 or up).

State LEDs. WC, AES, ADAT1, ADAT2. Indicate a valid input signal separately for each digital input. Additionally, RME's exclusive *SyncCheck* indicates if one of these inputs is locked, but not synchronous to the others, in which case the LED will flash. See also chapter 8.8 / 14.2, Clock Modes - Synchronization.

MIDI LEDs. Indicate separately for input and output if MIDI are received or transmitted.

The blue LED **USB** and **FW** extinguish if no USB or FireWire connection has been initialised, or has been interrupted (error, cable not connected etc.).

The rotary encoder **Volume** sets the monitoring volume directly at the device. Pushing the button will change between Main Out, Phones 1 and Phones 2. Watch the display for further information.

The four **keys**, the two **encoders 1** and **2**, the high-resolution and clear colour display, and a well thought-out menu structure enable the user to quickly change and configure the device's settings completely without a computer. Help notes and clear markers in the display guide the user through all functions.

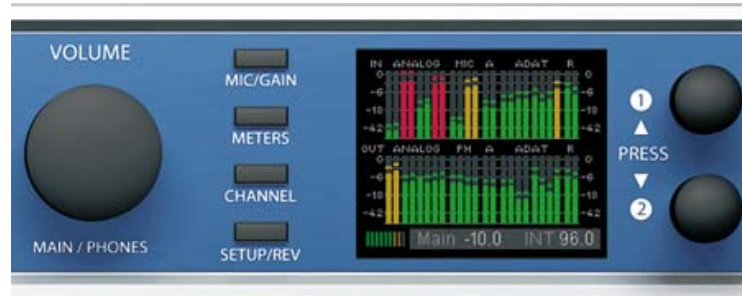

The rear panel of the Fireface UFX features eight analog inputs and outputs, the power socket, and all digital inputs and outputs:

Balanced Line Level Inputs. 8 balanced analog inputs via 6.3 mm stereo TRS.

Balanced Line Level Outputs. 8 balanced analog outputs, six via 6.3 mm stereo TRS, two via XLR.

AES/EBU I/O. XLR. The Fireface UFX accepts the commonly used digital audio formats, SPDIF as well as AES/EBU.

ADAT1 I/O. TOSLINK. Standard ADAT optical port, 8 channels.



ADAT2 I/O. TOSLINK. Standard ADAT optical port, 8 channels. Can also be used as optical SPDIF input and output, if set up accordingly in the Settings dialog.

Word Clock I/O. BNC. A push switch activates internal termination (75 Ohms). With termination activated the yellow LED besides the switch will light up.

Remote. Mini-DIN. Connector for the optional remote control with Volume, Store, Dim and Recall functions.

USB 2.0. USB socket for connection to the computer.

FW 400. 6-pin FireWire socket for connection to the computer.

MIDI I/O 1. Two 5-pin DIN connectors provide the first MIDI input and output.

IEC receptacle for mains power connection. The specially developed, internal high-performance switch mode power supply makes the Fireface operate in the range of 100V to 240V AC. It is short-circuit-proof, has an integrated line filter, is fully regulated against voltage fluctuations, and suppresses mains interference.



5.2 Quick Start

After the driver installation (chapter 6 / 13) connect the TRS jacks or the XLR inputs with the analog signal source. The input sensitivity of the rear inputs can be changed in TotalMix (Input Channel Settings, Level), assuring the highest signal to noise ratio will be achieved. Also try to achieve an optimum input level by adjusting the source itself. Raise the source's output level until the peak level meters in TotalMix reach about -3 dB.

The analog line inputs of the Fireface UFX can be used with +4 dBu and -10 dBV signals. The electronic input stage can handle balanced (XLR, TRS jacks) and unbalanced (TS jacks) input signals correctly.

The signal level of the front inputs can also be optimized directly at the Fireface. The key MIC/GAIN gives direct access to this setting, which is then controlled by the encoders 1 and 2. A two-colour LED beside the sockets signals overload by a colour change from green to red.

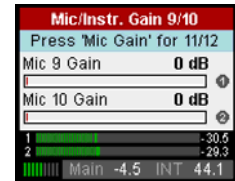

The digital outputs of the Fireface UFX provide AES/EBU (SPDIF compatible) and ADAT optical signals at the corresponding ports.

On the analog playback side (the DA side), a coarse adjustment of the analog output level at the rear jacks is available in TotalMix (Output Channel Settings, Level) or the Channel Settings directly at the device.

The output signal of channels 9/10 and 11/12 is available on the front. Their output level can be set using the VOLUME encoder. This output is a very low impedance type, which can also be used to connect headphones.

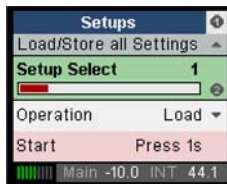
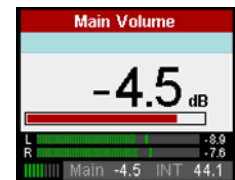

The Fireface UFX can store and load its current state in 6 different memory slots, called Setups. With this, the Fireface UFX can be used stand-alone after setting it up accordingly, replacing lots of dedicated devices (see chapter 24).

In online mode some settings are greyed out, as these should be changed only at the computer in the Settings dialog or in TotalMix. These include the choice of sample rate and the Mix settings.



User's Guide



Fireface UFX

► Installation and Operation – Windows

6. Hardware, Driver and Firmware Installation

6.1 Hardware and Driver Installation

To simplify installation it is recommended to first install the drivers before the unit is connected to the computer. But it will also work the other way round.

Insert the RME Driver CD into your CD-ROM drive. The driver installer is located in the directory **\Fireface_USB** or **\Fireface_FW**. Start *rmeinstaller.exe* and follow the instructions of the installer. After installation connect computer and UFX using a USB or FireWire cable. Windows detects the new hardware as **Fireface UFX** and installs the drivers automatically.

After a reboot, the icons of TotalMix FX and Settings dialog appear in the notification area.

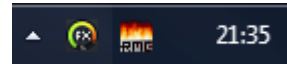

Driver Updates do not require to remove the existing drivers. Simply install the new driver over the existing one.

Note: FireWire and USB can be connected at the same time, but it is not recommended. Upon start of the computer the port that becomes active first will be used. With no port active the unit searches on both USB and FireWire until it finds an active one.

Possible reasons why a Fireface is not found automatically:

- The USB or FireWire port is not active in the system (check in Device Manager)
- The USB or FireWire cable is not, or not correctly inserted into the socket

6.2 De-installing the Drivers

A de-installation of the driver files is not necessary – and not supported by Windows anyway. Thanks to full Plug & Play support, the driver files will not be loaded after the hardware has been removed. If desired these files can then be deleted manually.

Unfortunately Windows Plug & Play methods do not cover the additional autorun entries of TotalMix, the Settings dialog, and the registration of the ASIO driver. These entries can be removed from the registry by a software de-installation request. This request can be found (like all de-installation entries) in *Control Panel, Software*. Click on the entry 'RME Fireface'.

6.3 Firmware Update

The Flash Update Tool updates the firmware of the Fireface UFX to the latest version. It requires an already installed driver.

Start the program **fut_usb.exe**. The Flash Update Tool displays the current revision of the Fireface firmware, and whether it needs an update or not. If so, then simply press the 'Update' button. A progress bar will indicate when the flash process is finished (Verify Ok).

After the update the unit needs to be reset. This is done by powering down the unit for a few seconds. A reboot of the computer is not necessary.

When the update unexpectedly fails (status: failure), the unit's Safety BIOS will be used from the next boot on, the unit stays fully functional. The flash process should then be tried again.

7. Configuring the Fireface

7.1 Settings dialog - General

Configuration of the Fireface UFX is done via its own settings dialog. The panel 'Settings' can be opened:

- by clicking on the fire symbol in the Task Bar's system tray

The mixer of the Fireface UFX, TotalMix, can be opened:

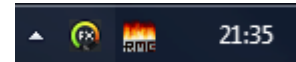

- by clicking on the DSP FX symbol in the Task Bar's system tray

The hardware of the Fireface UFX offers a number of helpful, well thought-of practical functions and options which affect how the card operates - it can be configured to suit many different requirements.

The following is available in the 'Settings' dialog:

- Latency
- Operation of the DSP
- Configuration of the digital I/Os
- Current sample rate
- Synchronization behaviour
- State of input and output

Any changes made in the Settings dialog are applied immediately - confirmation (e.g. by clicking on OK or exiting the dialog) is not required.

However, settings should not be changed during playback or record if it can be avoided, as this can cause unwanted noises.

Also, please note that even in 'Stop' mode, several programs keep the recording and playback devices open, which means that any new settings might not be applied immediately.

The tab **About** includes information about the current driver and firmware version of the Fireface UFX plus two more options:

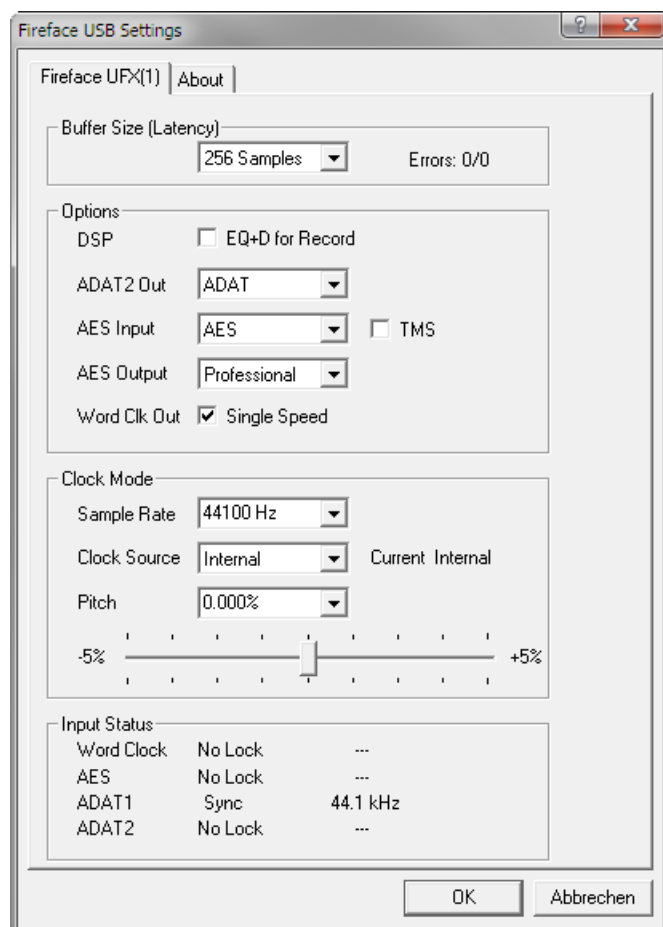

Lock Registry

Default: off. Checking this option brings up a dialog to enter a password. Changes in the Settings dialog are no longer written to the registry. As the settings are always loaded from the registry when starting the computer, this method provides an easy way to define an initial state of the Fireface UFX.

Enable MMCSS for ASIO activates support with higher priority for the ASIO driver. Note: At this time, activating this option seems to be useful only with the latest Cubase/Nuendo at higher load. With other software this option can decrease performance. The change becomes active after an ASIO reset. Therefore it is easy to quickly check which setting works better.

Buffer Size

The setting *Buffer Size* determines the latency between incoming and outgoing ASIO and WDM data, as well as affecting system stability (see chapter 9.1).

Errors does not refer to buffer errors, but USB and FireWire transmission errors. The display will be reset on any start of a playback/record. More information can be found in chapter 38.3 / 38.4.

Options

DSP – EQ+D for Record

Switches EQ and Dynamics of all input channels into the recording path. In case Loopback has been activated the EQ and Dynamics of the Output channel are within the recording path. See also chapter 27.5.

ADAT2

This optical TOSLINK output can operate as ADAT or AES/SPDIF output.

AES Input

Defines the input for the AES (SPDIF) signal. 'AES' relates to the XLR socket, 'ADAT2' to the second optical TOSLINK input. **TMS** activates the transmission of Channel Status data and Track Marker information. In case these information are not required the feature should be turned off.

AES Output

The AES output signal can have the Channel Status Professional or Consumer (SPDIF). This setting is also valid when ADAT2 has been set as AES output. For further details please refer to chapter 21.2.

Word Clk Out

The word clock output signal usually equals the current sample rate. Selecting *Single Speed* causes the output signal to always stay within the range of 32 kHz to 48 kHz. So at 96 kHz and 192 kHz sample rate, the output word clock is 48 kHz.

Clock Mode

Sample Rate

Sets the currently used sample rate. Offers a central and comfortable way of configuring the sample rate of all WDM devices to the same value, as since Vista the audio software is no longer allowed to set the sample rate. However, an ASIO program can still set the sample rate by itself.

During record/playback the selection is greyed out, so no change is possible.

Clock Source

The unit can be configured to use its own clock (Internal = Master), or one of the input signals (Word, AES, ADAT1 and ADAT2). If the selected source isn't available (Input Status No Lock), the unit will change to the next available one (AutoSync). If none is available then the internal clock is used. The current clock source is displayed as *Current*.

Pitch

More information on Pitch is available in chapter 7.2.

Input Status

Indicates for each input (Word, AES, ADAT1, ADAT2) whether there is a valid signal (Lock, No Lock), or if there is a valid *and* synchronous signal (Sync). The third column shows the sample frequency detected by the hardware (coarse recognition, 32 kHz, 44.1 kHz, 48 kHz etc.). In *Clock Mode* the clock reference is shown. See also chapter 38.1.

Bandwidth (only for the FireWire driver)

Allows to reduce the amount of bandwidth used on the FireWire bus. See chapter 38.4.

All channels (default) activates all 30 input and output channels.

Analog + AES + ADAT1 disables channels 23–30 (ADAT2).

Analog + AES activates all 12 analog channels plus AES.

Analog 1-8 activates only the first eight analog channels.

7.2 Settings Dialog - Pitch

Usually soundcards and audio interfaces generate their internal clock (master mode) by a quartz. Therefore the internal clock can be set to 44.1 kHz or 48 kHz, but not to a value in between. SteadyClock, RME's sensational Low Jitter Clock System, is based on a Direct Digital Synthesizer (DDS). This superior circuitry can generate nearly any frequency with highest precision.

DDS has been implemented into the Fireface with regard to the needs of professional video applications, as well as to maximum flexibility. The section Pitch includes both a list of typical video frequencies (so called pull up/pull down at 0.1% and 4%) and a fader to freely change the basic sample rate in steps of 1 Hz (!) over a range of +/- 5%.

 *The Pitch function requires the Fireface to be in clock mode Master! The frequency setting will only be applied to this one specific Fireface!*

 *Changing the sample rate during record/playback often results in a loss of audio, or brings up warning messages of the audio software. Therefore the desired sample rate should be set at least coarsely before starting the software.*

Coarse

Coarse modification in steps of 50 Hz is done by clicking with the mouse to the left and right of the fader knob.

Fine

Fine modification in steps of 1 Hz is done by using the left/right cursor keys.

Reset

Ctrl key plus left mouse click.

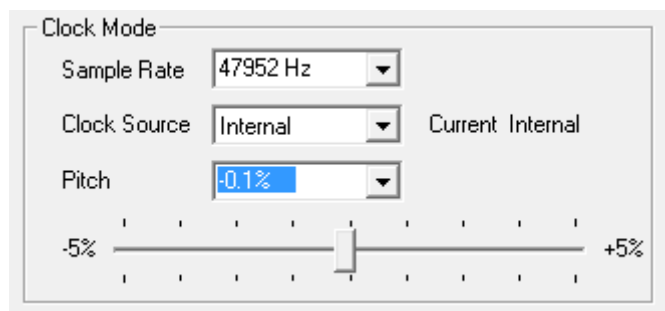

Application examples

Pitch allows for a simultaneous change of speed and tune during record and playback. From alignment to other sources up to creative effects – everything is possible.

Pitch enables you to intentionally de-tune the complete DAW. This way, the DAW can match instruments which have a wrong or unchangeable tuning.

Pitch allows for the change of the sample rate of all WDM devices at the same time. Since Vista this is no longer possible via the audio program, thus requires a manual reconfiguration of all WDM devices. Changing the sample rate from the Settings dialog solves this problem. As the change within the system requires some time, record/playback should not be started immediately, but only after at least 5 seconds after a change.

Tip: the current CPU load can be used to determine if the audio subsystem has finished the re-configuration.

8. Operation and Usage

8.1 Playback

The Fireface UFX can play back audio data in supported formats only (sample rate, bit resolution). Otherwise an error message appears (for example at 22 kHz and 8 bit).

In the audio application being used, Fireface must be selected as output device. This can often be found in the *Options*, *Preferences* or *Settings* menus under *Playback Device*, *Audio Devices*, *Audio* etc.

We strongly recommend switching all system sounds off (via >*Control Panel /Sounds*<). Also Fireface should not be the *Preferred Device* for playback, as this could cause loss of synchronization and unwanted noises. If you feel you cannot do without system sounds, you should consider buying a cheap Blaster clone and select this as *Preferred Device* in >*Control Panel /Multimedia /Audio*< or >*Control Panel /Sound /Playback*<.

The screenshot shows a typical configuration dialog of a (stereo) wave editor. Audio data is sent to an analog or digital port, depending on which has been selected as playback device.

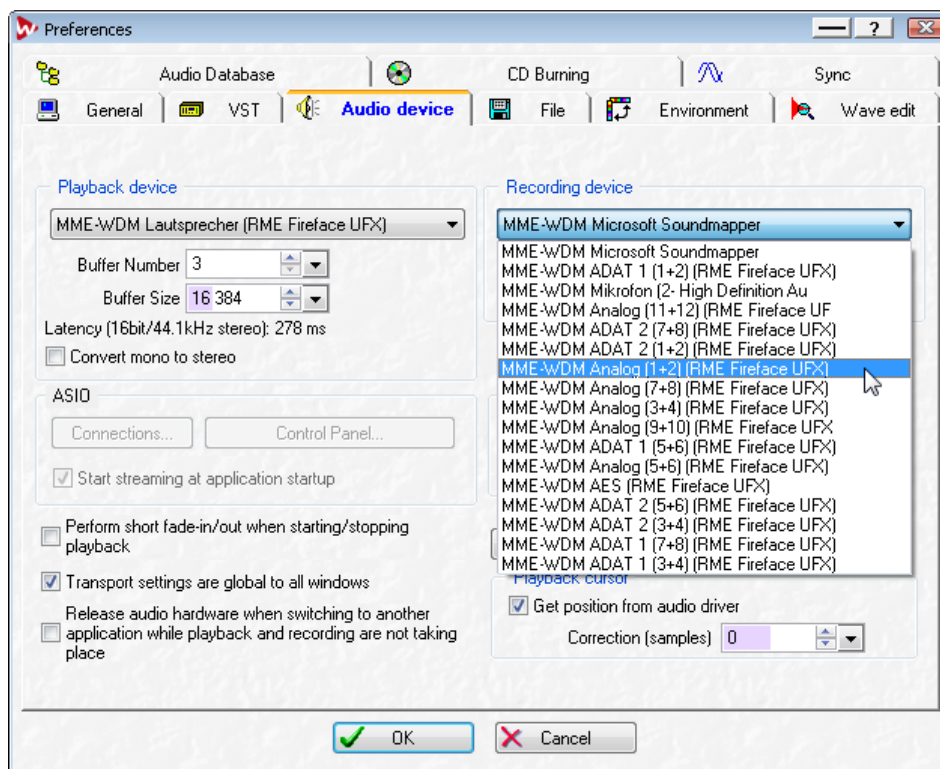

Increasing the number and/or size of audio buffers may prevent the audio signal from breaking up, but also increases latency i.e. output is delayed. For synchronized playback of audio and MIDI (or similar), be sure to activate the checkbox 'Get position from audio driver'.

Note: Since Vista the audio application can no longer control the sample rate under WDM. Therefore the driver of the Fireface UFX includes a way to set the sample rate globally for all WDM devices within the Settings dialog, see chapter 7.1.

8.2 DVD-Playback (AC-3/DTS)

AC-3 / DTS

When using popular DVD software players like *WinDVD* and *PowerDVD*, their audio data stream can be sent to any AC-3/DTS capable receiver using the Fireface's SPDIF output. For this to work, the WDM SPDIF device of the Fireface has to be selected in *>Control Panel/ Sounds and Multimedia/ Audio<* or *>Control Panel/ Sound/Playback<*. Also check 'use preferred device only'.

The DVD software's audio properties now show the options 'SPDIF Out' or similar. When selecting it, the software will transfer the non-decoded digital multichannel data stream to the Fireface.

Note: This 'SPDIF' signal sounds like chopped noise at highest level. Try to avoid mixing and routing the signal to your loudspeakers, as they might get damaged.

Multichannel

PowerDVD and WinDVD can also operate as software decoder, sending a DVD's multichannel data stream directly to the analog outputs of the Fireface. For this to work select the WDM playback device 'Loudspeaker' of the Fireface in

XP: *>Control Panel/ Sounds and Multimedia/ Audio<*, and check 'Use only default devices'. Additionally the loudspeaker setup, found under *>Volume/ Speaker Settings/ Advanced<* has to be changed from *Stereo* to *5.1 Surround*.

Since Vista: *>Control Panel/ Sound/ Playback <* as 'Standard'. Additionally the loudspeaker setup, found under *>Configuration<*, has to be changed from *Stereo* to *5.1 Surround*.

PowerDVD's and WinDVD's audio properties now list several multichannel modes. If one of these is selected, the software sends the decoded analog multichannel data to the Fireface. TotalMix can then be used to play back via any desired output channels.

The typical channel assignment for surround playback is:

- 1 - Left
- 2 - Right
- 3 - Center
- 4 - LFE (Low Frequency Effects)
- 5 - SL (Surround Left)
- 6 - SR (Surround Right)

Note 1: Selecting the Fireface to be used as system playback device is against our recommendations, as professional interfaces should not be disturbed by system events. Make sure to re-assign the selection after usage or to disable any system sounds (tab Sounds, scheme 'No audio').

Note 2: The DVD player will be synced backwards from the Fireface. This means when using AutoSync and/or word clock, the playback speed and pitch follows the incoming clock signal.

8.3 Notes on WDM

The driver offers a WDM streaming device per stereo pair, like **Analog 3+4 (Fireface UFX)**. WDM streaming is Microsoft's current driver and audio system, directly embedded into the operating system. WDM streaming is hardly usable for professional music purposes, as all data is processed by the so called Kernel Mixer, causing a latency of at least 30 ms. Additionally, WDM can perform sample rate conversions unnoticed, cause offsets between record and playback data, block channels unintentionally and much more.

Several programs do not offer any direct device selection. Instead they use the *playback device* selected in Windows under

XP: <Control Panel/ Sounds and Multimedia/ Audio>

Since Vista: <Control Panel/ Sound/ Playback>

The program *Sonar* from Cakewalk is unique in many ways. Sonar uses the so called **WDM Kernel Streaming**, bypassing the WDM mixer, thus achieves a similar performance to ASIO.

Because of the driver's multichannel streaming ability Sonar not only finds the stereo device mentioned above, but also the 8-channel interleaved devices, and adds the channel number at the end:

Fireface Analog (1+2) 1/2 is the first stereo device

Fireface Analog (3+4) is the next stereo device

Fireface Analog (1+2) 3/4 are the channels 3/4 of the first 8-channel interleaved device.

It is not recommended to use these special interleaved devices. Also it is not possible to use one stereo channel twice (the basic and the interleaved device).

Multi-Channel using WDM

The WDM Streaming device *Loudspeaker* (Analog 1+2) of the RME driver can operate as usual stereo device, or as up to 8-channel device.

An 8-channel playback using the Windows Media Player requires the speaker setup *7.1 Surround*. Configure as follows:

XP: >Control Panel /Sounds and Multimedia /Audio /Volume /Speaker Settings /Advanced <

Since Vista: >Control Panel /Sound /Playback /Loudspeaker /Configure <

8.4 Channel Count under WDM

The Fireface ADAT optical ports allow to record sample rates of up to 192 kHz using a standard ADAT recorder. For this to work single-channel data is spread to two or four ADAT channels using the *Sample Multiplexing* technique. This reduces the number of available ADAT channels from 8 to 4 or 2 per ADAT port.

Whenever the Fireface changes into Double Speed (88.2/96 kHz) or Quad Speed mode (176.4/192 kHz) all devices no longer available vanish automatically.

WDM Stereo device	Double Speed	Quad Speed
Fireface Analog (1+2)	Fireface Analog (1+2)	Fireface Analog (1+2)
Fireface Analog (3+4)	Fireface Analog (3+4)	Fireface Analog (3+4)
Fireface Analog (5+6)	Fireface Analog (5+6)	Fireface Analog (5+6)
Fireface Analog (7+8)	Fireface Analog (7+8)	Fireface Analog (7+8)
Fireface Analog (9+10)	Fireface Analog (9+10)	Fireface Analog (9+10)
Fireface SPDIF	Fireface SPDIF	Fireface SPDIF
Fireface ADAT 1 (1+2)	Fireface ADAT 1 (1+2)	Fireface ADAT 1 (1+2)
Fireface ADAT 1 (3+4)	Fireface ADAT 1 (3+4)	Fireface ADAT 1 (3+4)
Fireface ADAT 1 (5+6)	Fireface ADAT 1 (5+6)	Fireface ADAT 1 (5+6)
Fireface ADAT 1 (7+8)	Fireface ADAT 1 (7+8)	Fireface ADAT 1 (7+8)
Fireface ADAT 2 (1+2)	Fireface ADAT 2 (1+2)	Fireface ADAT 2 (1+2)
Fireface ADAT 2 (3+4)	Fireface ADAT 2 (3+4)	Fireface ADAT 2 (3+4)
Fireface ADAT 2 (5+6)	Fireface ADAT 2 (5+6)	Fireface ADAT 2 (5+6)
Fireface ADAT 2 (7+8)	Fireface ADAT 2 (7+8)	Fireface ADAT 2 (7+8)

Note: Since Vista the analog outputs 1/2 show up as *Loudspeaker*.

8.5 Multi-client Operation

RME audio interfaces support multi-client operation. Several programs can be used at the same time. The formats ASIO and WDM can even be used on the same playback channels simultaneously. But as WDM uses a real-time sample rate conversion (ASIO does not), all active ASIO software has to use the same sample rate.

However, a better overview is maintained by using the channels exclusively. This is no limitation at all, because TotalMix allows for any output routing, and therefore a playback of multiple software on the same hardware outputs.

Inputs can be used from an unlimited number of WDM and ASIO software at the same time, as the driver simply sends the data to all applications simultaneously.

RME's sophisticated tool *DIGICheck* is an exception to this rule. It operates like an ASIO host, using a special technique to access playback channels directly. Therefore DIGICheck is able to analyse and display playback data from any software, no matter which format it uses.

8.6 Analog Recording

For recordings via the analog inputs the corresponding record device has to be chosen (Fireface UFX Analog (x+x)).

The input sensitivity of the rear inputs can be changed in three steps in TotalMix (Input Channel Settings, Level), assuring the highest signal to noise ratio will be achieved. A further optimization can be achieved by adjusting the source itself. Raise the source's output level until the peak level meters in TotalMix reach about -3 dB.

The level of the front-side analog inputs can be optimized via TotalMix (Input Channel Settings, Gain), or directly at the Fireface UFX by the key Mic/Gain and the encoders 1/2. A double coloured signal and clip LED provides useful information about the current level state.

Further information is found in chapter 19.

It often makes sense to monitor the input signal or send it directly to the output. This can be done at zero latency using **TotalMix** (see chapter 25).

An *automated* control of real-time monitoring can be achieved by Steinberg's ASIO protocol with RME's ASIO drivers and all ASIO 2.0 compatible programs. When 'ASIO Direct Monitoring' has been switched on, the input signal is routed in real-time to the output whenever a recording is started (punch-in).

8.7 Digital Recording

Unlike analog soundcards which produce empty wave files (or noise) when no input signal is present, digital interfaces always need a valid input signal to start recording.

Taking this into account, RME added a comprehensive I/O signal status display to the Fireface UFX, showing sample frequency, lock and sync status for every input, and several status LEDs directly at the unit.

The sample frequency shown in the fields Clock Mode and Input Status is useful as a quick display of the current configuration of the unit and the connected external equipment. If no sample frequency is recognized, it will read 'No Lock'.

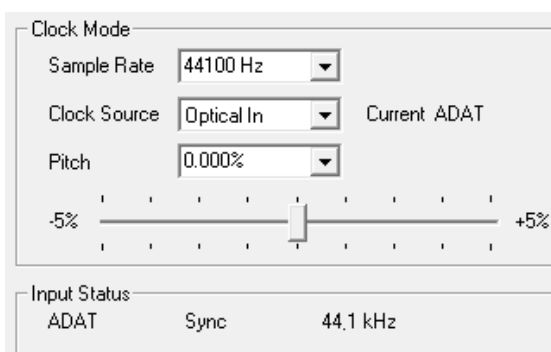

This way, configuring any suitable audio application for digital recording is simple. After selecting the correct input, Fireface UFX displays the current sample frequency. This parameter can then be changed in the application's audio attributes (or similar) dialog.

8.8 Clock Modes - Synchronization

In the digital world, all devices must be either Master (clock source) or Slave (clock receiver). Whenever several devices are linked within a system, there must always be a single master clock.



A digital system can only have one master! If the Fireface's clock mode is set to 'Master', all other devices must be set to 'Slave'.

The Fireface UFX utilizes a very user-friendly, intelligent clock control, called **AutoSync**. In AutoSync mode, the system constantly scans the digital input for a valid signal. If any valid signal is found, the Fireface switches from the internal quartz (*Clock Mode – Current Internal*) to a clock extracted from the input signal (*Clock Mode – Current ADAT, AES or Word*). The difference to a usual slave mode is that whenever the clock reference fails, the system will automatically use its internal clock and operate in clock mode Master.

AutoSync guarantees that record and record-while-play will always work correctly. In certain cases however, e.g. when the inputs and outputs of a DAT machine are connected directly to the Fireface UFX, AutoSync may cause feedback in the digital carrier, so synchronization breaks down. To solve this problem switch the Fireface clock mode to Master (Clock Source – Internal).

The Fireface's ADAT optical and AES inputs operate simultaneously. Because there is no input selector however, the unit has to be told which one of the signals is the sync reference (a digital device can only be clocked from a *single* source). By selecting a Clock Source a preferred input is defined. As long as the unit sees a valid signal there, this input will be designated as the sync source.

In some situations changing the clock mode can not be avoided. Example: An ADAT recorder is connected to the ADAT input (ADAT immediately becomes the AutoSync source) and a CD player is connected to the AES input. Try recording a few samples from the CD and you will be disappointed - few CD players can be synchronized. The samples will inevitably be corrupted, because the signal from the CD player is read with the clock from the ADAT. In this case the Clock Source should be temporarily set to AES.

RME's exclusive **SyncCheck** technology (first implemented in the Hammerfall) offers an easy to use check and display of the current clock status. *SyncCheck* indicates whether there is a valid signal (Lock, No Lock) for each input (Word Clock, ADAT, AES), or if there is a valid *and* synchronous signal (Sync). In the field *Clock Mode* the clock reference is shown. See chapter 38.1.

Under WDM the Fireface will (has to) set the sample rate. Therefore the error shown to the right can occur. A stable signal with a sample rate of 32 kHz is detected at the ADAT input (Sync), but Windows audio had been set to 44100 Hz before. The red colour of the text label signals the error condition, and prompts the user to set 32000 Hz manually as sample rate. Under ASIO the audio software sets the sample rate, so that such an error can not happen. If the input sample rate is different then there will be no Sync indication.

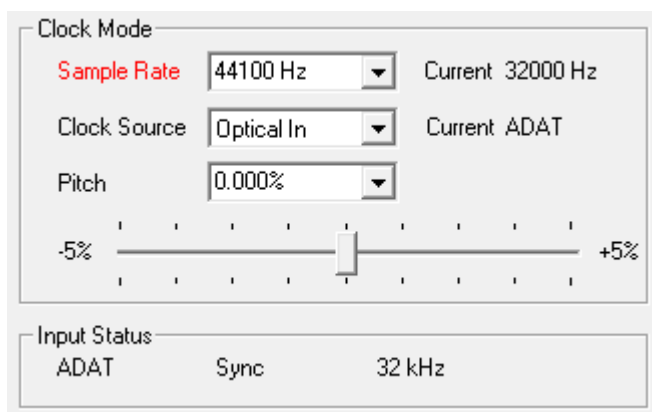

In practice, SyncCheck provides the user with an easy way of checking whether all digital devices connected to the system are properly configured. With SyncCheck, finally anyone can master this common source of error, previously one of the most complex issues in the digital studio world.

9. Operation under ASIO

9.1 General

Start the ASIO software and select **ASIO Fireface USB** as the audio I/O device or the audio driver.

The Fireface UFX supports *ASIO Direct Monitoring* (ADM).

The Fireface UFX MIDI I/O can be used with both MME MIDI and DirectMusic MIDI.

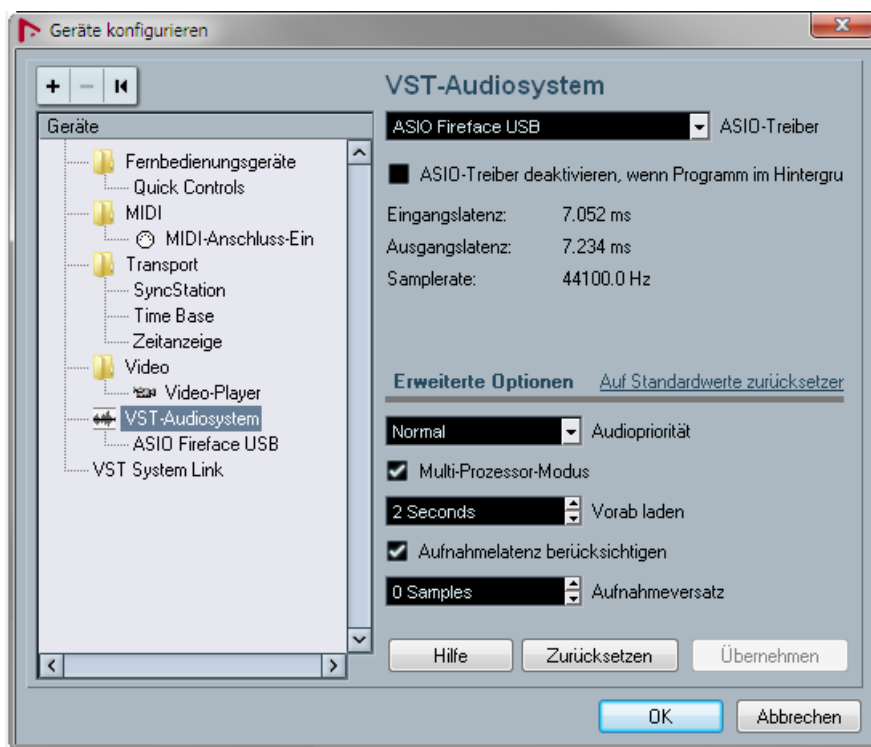

9.2 Channel Count under ASIO

At a sample rate of 88.2 or 96 kHz, the ADAT optical input and outputs operate in S/MUX mode, so the number of available channels per port is reduced from 8 to 4.

At a sample rate of 176.4 and 192 kHz, the ADAT optical input and output operates in S/MUX4 mode, so the number of available channels is limited to 2.

Note: When changing the sample rate range between Single, Double and Quad Speed the number of channels presented from the ASIO driver will change too. This may require a reset of the I/O list in the audio software.

Single Speed	Double Speed	Quad Speed
Fireface Analog 1 to 12	Fireface Analog 1 to 12	Fireface Analog 1 to 12
Fireface AES L / R	Fireface AES L / R	Fireface AES L / R
Fireface ADAT 1 to 16	Fireface ADAT 1 to 8	Fireface ADAT 1 to 4

9.3 Known Problems

If a computer does not provide sufficient CPU-power and/or sufficient USB or PCI* bus transfer rates, then drop outs, crackling and noise will appear. Raising the buffer size in the Settings dialog of the Fireface UFX helps in most cases. It is also recommended to deactivate all Plugins to verify that these are not the reason for such effects. Further information is found in chapter 38.3.

*The note on PCI is not an error in this manual: very often FireWire controllers are connected to the PCI bus. Therefore the same problems known from PCI audio cards can occur with FireWire audio interfaces as well. Further information is found in chapter 38.4.

Another common source of trouble is incorrect synchronization. ASIO does not support asynchronous operation, which means that the input and output signals not only have to use the same sample frequency, but also have to be in sync. All devices connected to the Fireface UFX must be properly configured for Full Duplex operation. As long as SyncCheck (in the Settings dialog) only displays *Lock* instead of *Sync*, the devices have not been set up properly!

The same applies when using more than one Fireface UFX - they all have to be in sync. Else a periodically repeated noise will be heard.

Fireface UFX supports *ASIO Direct Monitoring (ADM)*. Please note that not all programs support ADM completely or error-free. The most often reported problem is the wrong behaviour of panorama in a stereo channel. Also try to avoid setting the TotalMix FX hardware outputs (third row) to mono mode. This will most likely break ADM compatibility.

In case of a drift between audio and MIDI, or in case of a fixed deviation (MIDI notes placed close before or behind the correct position), the settings in Cubase/Nuendo have to be changed. At the time of print the option 'Use System Timestamp' should be activated. The Fireface supports both MME MIDI and DirectMusic MIDI. It depends on the used application which one will work better.

10. Using more than one Fireface UFX

The current driver supports up to three Fireface UFX. All units have to be in sync, i.e. have to receive valid sync information (either via word clock or by using AutoSync and feeding synchronized signals).

- If one of the Firefaces is set to clock mode Master, all others have to be set to clock mode AutoSync, and have to be synced from the master, for example by feeding word clock. The clock modes of all units have to be set up correctly in the Fireface Settings dialog.
- If all units are fed with a synchronous clock, i.e. all units show *Sync* in their Settings dialog, all channels can be used at once. This is especially easy to handle under ASIO, as the ASIO driver presents all units as one.

Note: TotalMix is part of the hardware of each Fireface. Up to three mixers are available, but these are separated and can't interchange data. Therefore a global mixer for all units is not possible.

In real-world an operation of more than one Fireface UFX makes no sense and is therefore not actively supported by RME. Each further unit would lead to problems on the USB and FireWire bus, caused by the high number of channels. The UFX has been developed as monitor controller and – not extendable – digital mixer. It makes more sense to connect external converters to the ADAT I/Os of the UFX, adding up to 16 channels of analog record and analog playback.

11. DIGICheck Windows

The DIGICheck software is a unique utility developed for testing, measuring and analysing digital audio streams. Although this Windows software is fairly self-explanatory, it still includes a comprehensive online help. DIGICheck 5.81 operates as multi-client ASIO host, therefore can be used in parallel to any software, be it WDM or ASIO, with both inputs and outputs (!). The following is a short summary of the currently available functions:

- **Level Meter.** High precision 24-bit resolution, 2/8/30 channels. Application examples: Peak level measurement, RMS level measurement, over-detection, phase correlation measurement, dynamic range and signal-to-noise ratios, RMS to peak difference (loudness), long term peak measurement, input check. Oversampling mode for levels higher than 0 dBFS. Vertical and horizontal mode. Slow RMS and RLB weighting filter. Supports visualization according to the K-System.
- **Hardware Level Meter for Input, Playback and Output.** Reference Level Meter freely configurable, causing near zero CPU load, because calculated from the Fireface hardware.
- **Vector Audio Scope.** World wide unique Goniometer showing the typical afterglow of a oscilloscope-tube. Includes Correlation meter and level meter.
- **Spectral Analyser.** World wide unique 10-, 20- or 30-band display in analog bandpass-filter technology. 192 kHz-capable!
- **Totalyser.** Spectral Analyser, Level Meter and Vector Audio Scope in a single window.
- **Surround Audio Scope.** Professional Surround Level Meter with extended correlation analysis, ITU weighting and ITU summing meter.
- **ITU1770/EBU R128 Meter.** For standardized loudness measurements.
- **Bit Statistics & Noise.** Shows the true resolution of audio signals as well as errors and DC offset. Includes Signal to Noise measurement in dB and dBA, plus DC measurement.
- **Channel Status Display.** Detailed analysis and display of SPDIF and AES/EBU Channel Status data.
- **Global Record.** Long-term recording of all channels at lowest system load.
- **Completely multi-client.** Open as many measurement windows as you like, on any channels and inputs or outputs!

To install DIGICheck, go to the **\\DIGICheck** directory on the RME Driver CD and run *setup.exe*. Follow the instructions prompted on the screen.

DIGICheck is constantly updated. The latest version is always available on our website www.rme-audio.com, section **Downloads / DIGICheck**.

12. Hotline – Troubleshooting

The newest information can always be found on our website www.rme-audio.com, section FAQ, Latest Additions.

The 8 ADAT channels don't seem to work

- The optical output ADAT2 has been switched to AES/SPDIF. As can be seen in the block diagram, all channels and their assignments still exist, but the optical transmitter has been disconnected from ADAT2 and is now fed from the AES output (channels 13/14). The ADAT2 playback devices are still usable by routing and mixing them in TotalMix to other outputs.

Playback works, but record doesn't

- Check that there is a valid signal at the input. If so, the current sample frequency is displayed in the Settings dialog.
- Check whether the Fireface UFX has been selected as recording device in the audio application.
- Check whether the sample frequency set in the audio application ('Recording properties' or similar) matches the input signal.
- Check that cables/devices have not been connected in a closed loop. If so, set the system's clock mode to Master.

Crackle during record or playback

- Increase the number and size of buffers in the 'Settings' dialog or in the application.
- Try different cables (coaxial or optical) to rule out any defects here.
- Check that cables/devices have not been connected in a closed loop. If so, set the system's clock mode to 'Master'.
- Check the Settings dialog for displayed Errors.

Driver installation and Settings dialog/TotalMix work, but a playback or record is not possible

- While recognition and control of the device are low bandwidth applications, playback/record needs the full FireWire transmission performance. Therefore, defective FireWire cables with limited transmission bandwidth can cause such an error scheme. The same is true for USB cables.



User's Guide



Fireface UFX

► Installation and Operation – Mac OS X

13. Hardware, Driver and Firmware Installation

13.1 Hardware and Driver Installation

After the Fireface has been connected to the computer and switched on install the drivers from the RME Driver CD. The driver files are located in the folder **\Fireface_USB** and **\Fireface_FW**. Installation works automatically by a double-click on the file **Fireface USB.pkg** or **Fireface.pkg**.

RME recommends downloading the latest driver version from the RME website. If done, the procedure is as follows:

USB: A double-click onto **driver_usb_mac.zip** expands the archive file to **Fireface USB.pkg**. Installation works automatically by a double-click on this file.

FW: A double-click onto **fireface_x86.zip** expands the archive file to **Fireface.pkg**. Installation works automatically by a double-click on this file.

During driver installation the programs **Totalmix** (TotalMix FX) and **Fireface USB Settings** or **Fireface Settings** are copied to the Applications folder. They will automatically start into the dock if a Fireface UFX is connected. A reboot of the computer is not required.

Driver Updates do not require to remove the existing drivers. Simply install the new driver over the existing one.

Note: FireWire and USB can be connected at the same time, but it is not recommended. However, the unit will use only one port. Upon start of the computer the port that becomes active first will be used. With no port active the unit searches on both USB and FireWire until it finds an active one.

Possible reasons why a Fireface is not found automatically:

- The USB or FireWire port is not active in the system (check in System Profiler)
- The USB or FireWire cable is not, or not correctly inserted into the socket

13.2 De-installing the Drivers

In case of problems the driver files can be deleted manually by dragging them to the trash bin:

USB

/Applications/Fireface USB Settings
/Applications/Totalmix
/System/Library/Extensions/FirefaceUSB.kext
/Users/username/Library/Preferences/de.rme-audio.TotalmixFX.plist
/Users/username/Library/Preferences/de.rme-audio.Fireface_USB_Settings.plist
/Library/LaunchAgents/de.rme-audio.firefaceUSBAgent.plist

FireWire

/Applications/Fireface Settings
/Applications/Totalmix
/System/Library/Extensions/FirefaceAudioDriver.kext
/Users/username/Library/Preferences/de.rme-audio.TotalmixFX.plist
/Users/username/Library/Preferences/de.rme-audio.FirefaceSettings.plist
/Library/LaunchAgents/de.rme-audio.firefaceAgent.plist

Under the latest Mac OS the User/Library folder is not visible in the Finder. To unhide it start Finder, click on the menu item Go. Hold down the option (alt) key, then click on Library.

13.3 Firmware Update

The Flash Update Tool updates the firmware of the Fireface UFX to the latest version. It requires an already installed driver.

Start the program **Fireface USB Flash**. The Flash Update Tool displays the current revision of the Fireface firmware, and whether it needs an update or not. If so, simply press the 'Update' button. A progress bar will indicate when the flash process is finished (Verify Ok).

After the update the Fireface UFX needs to be reset. This is done by powering down the Fireface for a few seconds. A reboot of the computer is not necessary.

When the update fails (status: failure), the unit's second BIOS will be used from the next cold boot on (Secure BIOS Technology). Therefore the unit stays fully functional. The flash process should then be tried again on a different computer.

14. Configuring the Fireface

14.1 Settings Dialog

Configuring the Fireface is done via its own settings dialog. Start the program **Fireface USB Settings**. The mixer of the Fireface UFX (TotalMix FX) can be configured by starting the program **Totalmix**.

The Fireface's hardware offers a number of helpful, well thought-out practical functions and options which affect how the card operates - it can be configured to suit many different requirements.

The following is available in the 'Settings' dialog:

- Operation of the DSP
- Configuration of digital I/Os
- Current sample rate
- Synchronization behaviour
- State of input and output

Any changes performed in the Settings dialog are applied immediately - confirmation (e.g. by exiting the dialog) is not required.

However, settings should not be changed during playback or record if it can be avoided, as this can cause unwanted noises.

Use the drop down menu **Properties For** to select the unit to be configured.

On the right of it the current firmware and driver version is shown.

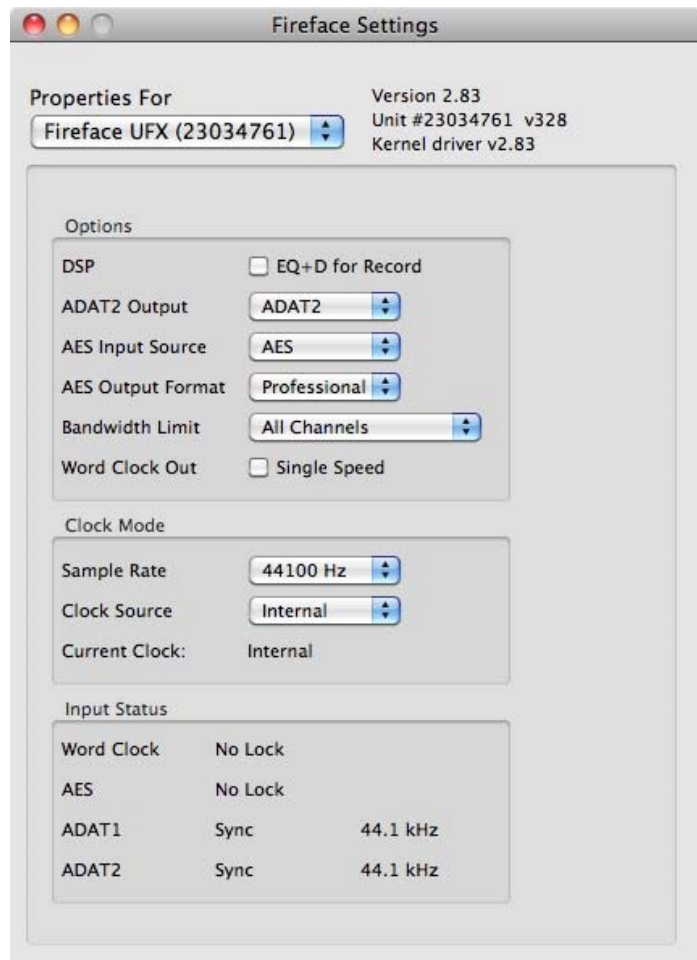

Options

DSP – EQ+D for Record

Switches EQ and Dynamics of all input channels into the recording path. In case Loopback has been activated the EQ and Dynamics of the Output channel are within the recording path. See also chapter 27.5.

ADAT2

This optical TOSLINK output can operate as ADAT or AES/SPDIF output.

AES Input

Defines the input for the AES (SPDIF) signal. 'AES' relates to the XLR socket, 'ADAT2' to the second optical TOSLINK input.

AES Output

The SPDIF output can have the Channel Status Consumer (SPDIF) or Professional indication. This setting is also valid when ADAT2 has been set as AES output. For further details please refer to chapter 21.2.

Word Clk Out

The word clock output signal usually equals the current sample rate. Selecting *Single Speed* causes the output signal to always stay within the range of 32 kHz to 48 kHz. So at 96 kHz and 192 kHz sample rate, the output word clock is 48 kHz.

Clock Mode

Sample Rate

Used to set the current sample rate. This is the same setting as in the Audio MIDI Setup, just added here for your convenience.

The unit can be configured to use its own clock (Internal = Master), or one of the input signals (Word, AES, ADAT1 and ADAT2). If the selected source isn't available (Input Status No Lock), the unit will change to the next available one (AutoSync). If none is available then the internal clock is used. The current clock source is displayed as *Current*.

Input Status

Indicates for each input (Word, AES, ADAT1, ADAT2) whether there is a valid signal (Lock, No Lock), or if there is a valid *and* synchronous signal (Sync). The third column shows the sample frequency detected by the hardware (coarse recognition, 32 kHz, 44.1 kHz, 48 kHz etc.). In *Clock Mode* the clock reference is shown. See also chapter 38.1.

Bandwidth (only for the FireWire driver)

Allows to reduce the amount of bandwidth used on the FireWire bus. See chapter 38.4.

All channels (default) activates all 30 input and output channels.

Analog + AES + ADAT1 disables channels 23–30 (ADAT2).

Analog + AES activates all 12 analog channels plus AES.

Analog 1-8 activates only the first eight analog channels.

14.2 Clock Modes - Synchronization

In the digital world, all devices must be either Master (clock source) or Slave (clock receiver). Whenever several devices are linked within a system, there must always be a single master clock.



A digital system can only have one master! If the Fireface's clock mode is set to 'Master', all other devices must be set to 'Slave'.

The Fireface UFX utilizes a very user-friendly, intelligent clock control, called **AutoSync**. In AutoSync mode, the system constantly scans the digital input for a valid signal. If any valid signal is found, the Fireface switches from the internal quartz (*Clock Mode – Current Internal*) to a clock extracted from the input signal (*Clock Mode – Current ADAT, AES or Word*). The difference to a usual slave mode is that whenever the clock reference fails, the system will automatically use its internal clock and operate in clock mode Master.

AutoSync guarantees that record and record-while-play will always work correctly. In certain cases however, e.g. when the inputs and outputs of a DAT machine are connected directly to the Fireface UFX, AutoSync may cause feedback in the digital carrier, so synchronization breaks down. To solve this problem switch the Fireface clock mode to Master (Clock Source – Internal).

The Fireface's ADAT optical and AES inputs operate simultaneously. Because there is no input selector however, the unit has to be told which one of the signals is the sync reference (a digital device can only be clocked from a *single* source). By selecting a Clock Source a preferred input is defined. As long as the unit sees a valid signal there, this input will be designated as the sync source.

In some situations changing the clock mode can not be avoided. Example: An ADAT recorder is connected to the ADAT input (ADAT immediately becomes the AutoSync source) and a CD player is connected to the AES input. Try recording a few samples from the CD and you will be disappointed - few CD players can be synchronized. The samples will inevitably be corrupted, because the signal from the CD player is read with the clock from the ADAT. In this case the Clock Source should be temporarily set to *AES*.

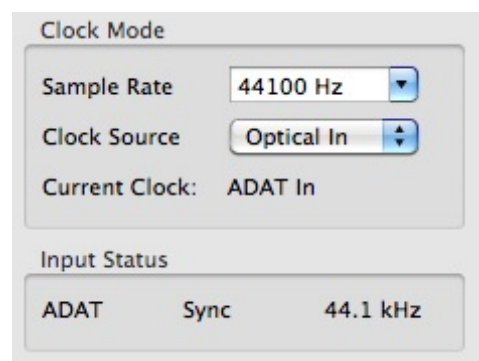

RME's exclusive **SyncCheck** technology (first implemented in the Hammerfall) enables an easy to use check and display of the current clock status. *SyncCheck* indicates whether there is a valid signal (Lock, No Lock) for each input (Word Clock, ADAT, AES), or if there is a valid *and* synchronous signal (Sync). In the field *Clock Mode* the clock reference is shown. See chapter 38.1.

In practice, SyncCheck provides the user with an easy way of checking whether all digital devices connected to the system are properly configured. With SyncCheck, finally anyone can master this common source of error, previously one of the most complex issues in the digital studio world.

15. Mac OS X FAQ

15.1 MIDI doesn't work

In some cases the applications do not show the MIDI port. The reason for this is usually visible within the **Audio MIDI Setup**. It displays no RME MIDI device, or the device is greyed out and therefore inactive. Mostly, removing the greyed out device and searching for MIDI devices again will solve the problem.

The Fireface is class compliant. Therefore it comes without a driver. OS X recognizes it as MIDI device and will be using it with the driver included in the operating system.

15.2 Repairing Disk Permissions

Repairing permission can solve problems with the installation process - plus many others. To do this, launch **Disk Utility** located in **Utilities**. Select your system drive in the drive/volume list to the left. The **First Aid** tab to the right now allows you to check and repair disk permissions.

15.3 Supported Sample Rates

RME's Mac OS X driver supports all sampling frequencies provided by the hardware. This includes **32 kHz** and **64 kHz**, and even **128 kHz**, **176.4 kHz** and **192 kHz**.

But not any software will support all the hardware's sample rates. The hardware's capabilities can easily be verified in the **Audio MIDI Setup**. Select **Audio devices** under **Properties of:** and choose the Fireface. A click on **Format** will list the supported sample frequencies.

15.4 Channel Count under Core Audio

At a sample rate of 88.2 or 96 kHz, the ADAT optical input and output operates in S/MUX mode, so the number of available channels is reduced from 8 to 4.

At a sample rate of 176.4 and 192 kHz, the ADAT optical input and output operates in S/MUX4 mode, so the number of available channels is limited to 2.

It is not possible to change the number of Core Audio devices without a reboot of the computer. Therefore whenever the Fireface changes into Double Speed (88.2/96 kHz) or Quad Speed mode (176.4/192 kHz) all devices stay present, but become partly inactive.

Single Speed	Double Speed	Quad Speed
Fireface Analog 1 to 12	Fireface Analog 1 to 12	Fireface Analog 1 to 12
Fireface AES L / R	Fireface AES L / R	Fireface AES L / R
Fireface ADAT 1 to 16	Fireface ADAT 1 to 8	Fireface ADAT 1 to 4

15.5 Various Information

The driver of the Fireface requires at least Mac OS 10.6.

Programs that don't support card or channel selection will use the device chosen as **Input** and **Output** in the **System Preferences – Sound** panel.

Via **Launchpad – Other – Audio MIDI Setup** the Fireface can be configured for the system wide usage in more detail.

Programs that don't support channel selection will always use channels 1/2, the first stereo pair. To access other inputs, use the following workaround with TotalMix: route the desired input signal to output channels 1/2. In the channel settings of outputs 1/2 activate *Loopback*. Result: the desired input signal is now available at input channel 1/2, without further delay/latency.

Use **Configure Speakers** to freely configure the stereo or multichannel playback to any available channels.

16. Using more than one Fireface

OS X supports the usage of more than one audio device within an audio software. This is done via the Core Audio function **Aggregate Devices**, which allows to combine several devices into one.

The current driver supports up to three Fireface 400 or 800. All units have to be in sync, i.e. have to receive valid sync information either via word clock or by feeding synchronized signals.

- If one of the Firefaces is set to clock mode Master, all others have to be set to clock mode Slave, and have to be synced from the master, for example by feeding word clock. The clock modes of all units have to be set up correctly in the Fireface Settings dialog.
- If all units are fed with a synchronous clock, i.e. all units show *Sync* in their Settings dialog, all channels can be used at once.

Note: TotalMix is part of the Fireface hardware. Up to three mixers are available, but these are separated and can't interchange data. Therefore a global mixer for all units is not possible.

In real-world an operation of more than one Fireface UFX makes no sense and is therefore not actively supported by RME. Each further unit would lead to problems on the USB and FireWire bus, caused by the high number of channels. The UFX has been developed as monitor controller and – not extendable – digital mixer. It makes more sense to connect external converters to the ADAT I/Os of the UFX, adding up to 16 channels of analog record and analog playback.

17. DIGICheck Mac

The DIGICheck software is a unique utility developed for testing, measuring and analysing digital audio streams. Although the software is fairly self-explanatory, it still includes a comprehensive online help. DIGICheck 0.690 operates in parallel to any software, showing all input data. The following is a short summary of the currently available functions:

- **Level Meter.** High precision 24-bit resolution, 2/8/30 channels. Application examples: Peak level measurement, RMS level measurement, over-detection, phase correlation measurement, dynamic range and signal-to-noise ratios, RMS to peak difference (loudness), long term peak measurement, input check. Oversampling mode for levels higher than 0 dBFS. Vertical and horizontal mode. Slow RMS and RLB weighting filter. Supports visualization according to the K-System.
- **Hardware Level Meter for Input, Playback and Output.** Reference Level Meter freely configurable, causing near zero CPU load, because calculated from the Fireface hardware.
- **Spectral Analyser.** World wide unique 10-, 20- or 30-band display in analog bandpass filter technology. 192 kHz-capable!
- **Vector Audio Scope.** World wide unique Goniometer showing the typical afterglow of a oscilloscope-tube. Includes Correlation meter and level meter.
- **Totalyser.** Spectral Analyser, Level Meter and Vector Audio Scope in a single window.
- **Surround Audio Scope.** Professional Surround Level Meter with extended correlation analysis, ITU weighting and ITU summing meter.
- **ITU1770/EBU R128 Meter.** For standardized loudness measurements.
- **Bit Statistics & Noise.** Shows the true resolution of audio signals as well as errors and DC offset. Includes Signal to Noise measurement in dB and dBA, plus DC measurement.
- **Completely multi-client.** Open as many measurement windows as you like, on any channels and inputs or outputs!

To install DIGICheck, go to the **\DIGICheck** directory on the RME Driver CD and run *setup.exe*. Follow the instructions prompted on the screen.

DIGICheck is constantly updated. The latest version is always available on our website www.rme-audio.com, section **Downloads / DIGICheck**.

18. Hotline – Troubleshooting

The newest information can always be found on our website www.rme-audio.com, section FAQ, latest Additions.

The unit and drivers have been installed correctly, but playback does not work:

- Is Fireface UFX listed in the System Profiler? (Vendor ID 2613).
- Has Fireface been selected as current playback device in the audio application?

The 8 ADAT channels don't seem to work

- The optical output ADAT2 has been switched to AES/SPDIF. As can be seen in the block diagram, all channels and their assignments still exist, but the optical transmitter has been disconnected from ADAT2 and is now fed from the AES output (channels 13/14). The ADAT2 playback devices are still usable by routing and mixing them in TotalMix to other outputs.

Playback works, but record doesn't:

- Check that there is a valid signal at the input. If so, the current sample frequency is displayed in the Settings dialog.
- Check whether the Fireface UFX has been selected as recording device in the audio application.
- Check whether the sample frequency set in the audio application ('Recording properties' or similar) matches the input signal.
- Check that cables/devices have not been connected in a closed loop. If so, set the system's clock mode to 'Master'.

Crackle during record or playback:

- Increase the number and size of buffers in the application.
- Try different cables (coaxial or optical) to rule out any defects here.
- Check that cables/devices have not been connected in a closed loop. If so, set the system's clock mode to 'Master'.
- Check the Settings dialog for displayed Errors.

Possible causes for a Fireface not working

- The FireWire or USB cable is not, or not correctly inserted into the socket

Driver installation and Settings dialog/TotalMix work, but a playback or record is not possible

- While recognition and control of the device are low bandwidth applications, playback/record needs the full FireWire transmission performance. Therefore, defective FireWire cables with limited transmission bandwidth can cause such an error scheme. The same is true for USB cables.

User's Guide



Fireface UFX

► Inputs and Outputs

19. Analog Inputs

19.1 Line Rear

The Fireface has eight balanced Line inputs as 1/4" TRS jacks on the back of the unit. The electronic input stage is built in a servo balanced design which handles unbalanced (mono jacks) and balanced (stereo jacks) correctly, automatically adjusting the level reference.



When using unbalanced cables with TRS jacks: be sure to connect the 'ring' contact of the TRS jack to ground. Otherwise noise may occur, caused by the unconnected negative input of the balanced input.

One of the main issues when working with an AD-converter is to maintain the full dynamic range within the best operating level. Therefore the Fireface UFX internally uses hi-quality electronic switches, which allow for a perfect adaptation of all rear inputs individually to the three most often used studio levels.

The Fireface UFX uses the following level references:

Reference	0 dBFS @	Headroom
Lo Gain	+19 dBu	15 dB
+4 dBu	+13 dBu	9 dB
-10 dBV	+2 dBV	12 dB

The above levels are also found in all other RME devices. Therefore they are fully compatible to each other.

19.2 Microphone / Line / Inst Front

The four balanced microphone inputs of the Fireface UFX offer a digitally controlled gain of 0 to 65 dB via XLR/TRS combo jacks. The gain range is 65 dB, adjustable in 1 dB-steps over a range of 55 dB. The soft switching, hi-current Phantom power (48 Volt), switchable per channel, provides a professional handling of condenser mics. Up to a level of +12 dBu, the front XLR input can also be used as Line input.

The unbalanced TRS Line inputs, which can be used alternatively, add even greater flexibility to the Fireface UFX. With 800 kOhm input impedance (Hi-Z), TRS jack and adjustable input gain over a range of 55 dB the front-side inputs can be used perfectly with keyboards, sampler, CD player, guitars and much more. These inputs handle levels from -34 dBu up to +21 dBu, turning them into full level Line inputs. Thus the unit can also be used as Line gain amplifier.

The TRS jacks are free of phantom power.

A two colour LED display a present signal (green, from -46 dBFS) and warns against overload (0 dBFS).

Channels 9 to 12 feature an automatic overload protection. **AutoSet** tries to keep a headroom of 6 dB. Levels higher than -6 dBFS will permanently reduce the gain. To check set the channels to a high gain and apply an input signal. The button will quickly rotate back to a gain that is appropriate. While AutoSet in the UFX is not exactly the same as in the RME Micstasy (with extreme overloads distortion will occur for the fraction of a second before the level is set correctly), it works quite well in real-world applications and will prevent distorted recordings reliably.

Using stereo channels AutoSet operates ganged. AutoSet can be activated in TM FX or directly at the unit in the channel settings. A push on Encoder 1/2 toggles AS on/off.

As soon as AutoSet reduces the gain the label AS, shown in the front display, changes its color from black to dark blue.

20. Analog Outputs

20.1 Line

The short circuit protected, low impedance line outputs of channels 3 to 8 are available as 1/4" TRS jacks on the back of the unit. The electronic output stage is built in a servo balanced design which handles unbalanced (mono jacks) and balanced (stereo jacks) correctly.

To maintain an optimum level for devices connected to the analog outputs, the Fireface UFX internally uses hi-quality electronic switches, which allow for a perfect adaptation of all outputs to the three most often used studio levels.

As with the analog inputs, the analog output levels are defined to maintain a problem-free operation with most other devices. The headroom of the Fireface UFX lies between 9 and 15 dB, according to the chosen reference level:

Reference	0 dBFS @	Headroom
Hi Gain	+19 dBu	15 dB
+4 dBu	+13 dBu	9 dB
-10 dBV	+2 dBV	12 dB

The above levels are also found in all other RME devices. Therefore they are fully compatible to each other.

The outputs 1 and 2 use XLR sockets. They additionally offer an output level of +24 dBu, making these outputs compatible to SMPTE (+24 dBu @ 0 dBFS, +4 dBu with 20 dB headroom):

Reference	0 dBFS @	Headroom
+24 dBu	+24 dBu	20 dB



The electronic driver circuit of the XLR outputs does not operate servo-balanced! When connecting unbalanced equipment, make sure pin 3 of the XLR output is not connected. A connection to ground will cause higher THD (distortion)!

20.2 Headphones / Line Out

Channels 9 to 12 of the Fireface are available on the front as 1/4" TRS jacks. These channels use the same converters as the other Line outputs, therefore offer the same technical data (118 dBA SNR).

Two hardware-based reference levels are available (set in TotalMix Output Channel Settings, Level, High or Low). High equals the setting +4 dBu of the other channels, Low equals -10 dBV. They can thus also be used as high-quality (yet unbalanced) line outputs.

These outputs are special low impedance types, ready to be used with headphones.

Setting the output level, i.e. the monitoring volume, is done – besides the pre-setting High/Low - via TotalMix (Hardware Output, PH 9/10 and PH 11/12) or directly at the unit. Pushing the VOLUME knob changes between Main Out, Ph 9/10 and Ph 11/12. The device remembers the last choice. Changing the monitoring volume is therefore very easy and quickly done.

In case the output should operate as line output, an adapter TRS plug to RCA phono plugs, or TRS plug to TS plugs is required.

The pin assignment follows international standards. The left channel is connected to the tip, the right channel to the ring of the TRS jack/plug.

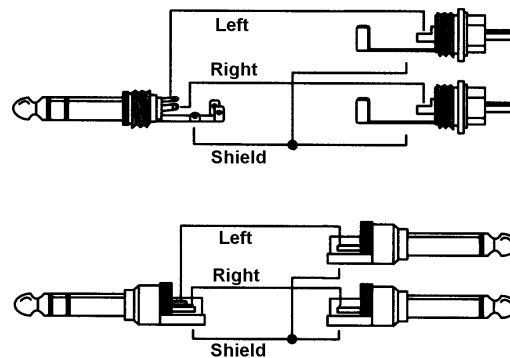

21. Digital Connections

21.1 ADAT

The ADAT optical inputs of the Fireface UFX are fully compatible with all ADAT optical outputs. RME's unsurpassed Bitclock PLL prevents clicks and drop outs even in extreme varipitch operation, and guarantees a fast and low jitter lock to the digital input signal. A usual TOSLINK cable is sufficient for connection.

ADAT1 In

Interface for the first or only device sending an ADAT signal to the Fireface UFX. Carries the channels 1 to 8. When receiving a Double Speed signal, this input carries the channels 1 to 4, at Quad Speed the channels 1 and 2.

ADAT2 In

Interface for the second device sending an ADAT signal to the Fireface UFX. Carries the channels 9 to 16. When receiving a Double Speed signal, this input carries the channels 5 to 8, at Quad Speed* the channels 3 and 4. Can also be used as SPDIF optical input.

ADAT1 Out

Interface for the first or only device receiving an ADAT signal from the Fireface UFX. Transmits channels 1 to 8. When sending a Double Speed signal, this port carries channels 1 to 4, at Quad Speed the channels 1 and 2.

ADAT2 Out

Interface for the second device receiving an ADAT signal from the Fireface UFX. Transmits channels 9 to 16. When sending a Double Speed signal, this port carries channels 5 to 8, at Quad Speed* the channels 3 and 4. Can also be used as SPDIF optical output.

* With Windows USB the ADAT channels 3/4 are not available at 176.4 and 192 kHz.

21.2 AES

The Fireface UFX provides one XLR AES/EBU input and output each. Connection is accomplished using balanced cables with XLR plugs. Input and Output are transformer-balanced and ground-free. The incoming channel status is ignored.

AES/EBU (and SPDIF) can contain Emphasis information. Audio signals with Emphasis have a strong high frequency boost, requiring high frequency attenuation on playback.



An Emphasis indication gets lost as there exists no standardized interface on computers to handle this information!

Input

Thanks to a highly sensitive input stage SPDIF coaxial can be fed too by using a simple cable adapter phono/XLR. To achieve this, pins 2 and 3 of a male XLR plug are connected individually to the two pins of a phono plug. The cable shielding is only connected to pin 1 of the XLR - not to the phono plug.

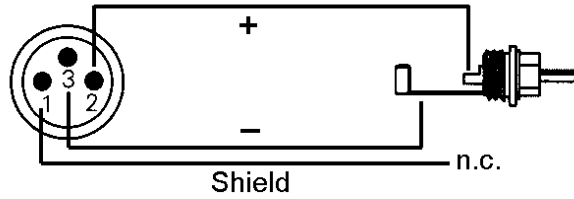

In AES operation, identical signals are available at both the optical and the XLR output. An obvious use for this would be to connect two devices, i.e. using the Fireface UFX as a splitter (distribution 1 on 2).

Output

Using the cable adapter XLR/phono described above, devices with coaxial SPDIF interface can be connected to the AES output of the Fireface UFX as well. Note that most consumer equipment with phono (SPDIF) inputs will only accept signals having a Channel Status 'Consumer' format. The Consumer status is activated in the Settings dialog of the Fireface UFX. In Consumer mode the output voltage is reduced as well, as SPDIF calls for a lower voltage than AES/EBU.

The output signal coding of the Fireface UFX has been implemented according to AES3-1992 Amendment 4:

- 32 / 44.1 / 48 kHz, 64 / 88.2 / 96 kHz, 176.4 / 192 kHz depending on the current sample rate
- Audio use
- No Copyright, Copy permitted
- Format Professional or Consumer
- Category General, Generation not indicated
- 2-Channel, No Emphasis
- Aux Bits Audio use, 24 Bit
- Origin: RME

21.3 MIDI

Fireface UFX offers two MIDI I/O via four 5-pin DIN sockets. The MIDI ports are added to the system by the driver. Using MIDI capable software, these ports can be accessed under the name *Fireface MIDI*. Using more than one Fireface, the operating system adds a consecutive number to the port name, like *Fireface MIDI (2)* etc.

The MIDI ports support multi-client operation. A MIDI input signal can be received from several programs at the same time. Even the MIDI output can be used by multiple programs simultaneously. However, due to the limited bandwidth of MIDI, this kind of application will often show various problems.

Note: The MIDI input LEDs display any kind of MIDI activity, including MIDI Clock, MTC and Active Sensing. The latter is sent by most keyboards every 0.3 seconds.

22. Word Clock

22.1 Word Clock Input and Output

SteadyClock guarantees an excellent performance in all clock modes. Based on the highly efficient jitter suppression, the Fireface refreshes and cleans up any clock signal, and provides it as reference clock at the BNC output (see section 32.8).

Input

The Fireface's word clock input is active when *Pref. Sync Ref* in the Settings dialog has been switched to *Word Clock*, the clock mode *AutoSync* has been activated, and a valid word clock signal is present. The signal at the BNC input can be Single, Double or Quad Speed, the Fireface UFX automatically adapts to it. As soon as a valid signal is detected, the WC LED is lit, and the Settings dialog shows either Lock or Sync (see chapter 38.1).

Thanks to RME's *Signal Adaptation Circuit*, the word clock input still works correctly even with heavily mis-shaped, dc-prone, too small or overshoot-prone signals. Thanks to automatic signal centering, 300 mV (0.3V) input level is sufficient in principle. An additional hysteresis reduces sensitivity to 1.0 V, so that over- and undershoots and high frequency disturbances don't cause a wrong trigger.

The Fireface's word clock input is shipped as high impedance type (not terminated). A push switch allows for internal termination (75 Ohms). The switch is found on the back beside the word clock input socket. Use a small pencil or similar and carefully push the blue switch so that it snaps into its lock position. The yellow LED will be lit when termination is active. Another push will release it again and de-activate the termination.



Output

The word clock output of the Fireface is constantly active, providing the current sample frequency as word clock signal. As a result, in Master mode the provided word clock is defined by the currently used software. In Slave mode the provided frequency is identical to the one present at the currently chosen clock input. When the current clock signal fails, the Fireface UFX switches to Master mode and adjusts itself to the next, best matching frequency (44.1 kHz, 48 kHz etc.).

Selecting *Single Speed* in the Settings dialog causes the output signal to always stay within the range of 32 kHz to 48 kHz. So at 96 kHz and 192 kHz sample rate, the output word clock is 48 kHz.

The received word clock signal can be distributed to other devices by using the word clock output. With this the usual T-adapter can be avoided, and the Fireface UFX operates as *Signal Refresher*. This kind of operation is highly recommended, because

- input and output are phase-locked and in phase (0°) to each other
- *SteadyClock* removes nearly all jitter from the input signal
- the exceptional input (1 Vpp sensitivity instead of the usual 2.5 Vpp, dc cut, *Signal Adaptation Circuit*) plus *SteadyClock* guarantee a secure function even with highly critical word clock signals

Thanks to a low impedance, short circuit proof output, the Fireface delivers 4 Vpp to 75 Ohms. For wrong termination with 2 x 75 Ohms (37.5 Ohms), there are still 3.3 Vpp at the output.

22.2 Technical Description and Usage

In the analog domain one can connect any device to another device, a synchronization is not necessary. Digital audio is different. It uses a clock, the sample frequency. The signal can only be processed and transmitted when all participating devices share the same clock. If not, the signal will suffer from wrong samples, distortion, crackle sounds and drop outs.

AES/EBU, SPDIF and ADAT are self-clocking, an additional word clock connection in principle isn't necessary. But when using more than one device simultaneously problems are likely to happen. For example any self-clocking will not work in a loop cabling, when there is no 'master' (main clock) inside the loop. Additionally the clock of all participating devices has to be synchronous. This is often impossible with devices limited to playback, for example CD players, as these have no SPDIF input, thus can't use the self clocking technique as clock reference.

In a digital studio synchronisation is maintained by connecting all devices to a central sync source. For example the mixing desk works as master and sends a reference signal, the word clock, to all other devices. Of course this will only work as long as all other devices are equipped with a word clock or sync input, thus being able to work as slave (some professional CD players indeed have a word clock input). Then all devices get the same clock and will work in every possible combination with each other.



A digital system can only have one master! If the Fireface's clock mode is set to 'Master', all other devices must be set to 'Slave'.

But word clock is not only the 'great problem solver', it also has some disadvantages. The word clock is based on a fraction of the really needed clock. For example SPDIF: 44.1 kHz word clock (a simple square wave signal) has to be multiplied by 256 inside the device using a special PLL (to about 11.2 MHz). This signal then replaces the one from the quartz crystal. Big disadvantage: because of the high multiplication factor the reconstructed clock will have great deviations called jitter. The jitter of a word clock is typically 15 times higher as when using a quartz based clock.

The end of these problems should have been the so called Superclock, which uses 256 times the word clock frequency. This equals the internal quartz frequency, so no PLL for multiplying is needed and the clock can be used directly. But reality was different, the Superclock proved to be much more critical than word clock. A square wave signal of 11 MHz distributed to several devices means to fight with high frequency technology. Reflections, cable quality, capacitive loads - at 44.1 kHz these factors may be ignored, at 11 MHz they are the end of the clock network. Additionally it was found that a PLL not only generates jitter, but also rejects disturbances. The slow PLL works like a filter for induced and modulated frequencies above several kHz. As the Superclock is used without any filtering such a kind of jitter and noise suppression is missing.

The actual end of these problems is offered by the **SteadyClock** technology of the Fireface UFX. Combining the advantages of modern and fastest digital technology with analog filter techniques, re-gaining a low jitter clock signal of 22 MHz from a slow word clock of 44.1 kHz is no problem anymore. Additionally, jitter on the input signal is highly rejected, so that even in real world usage the re-gained clock signal is of highest quality.

22.3 Cabling and Termination

Word clock signals are usually distributed in the form of a network, split with BNC T-adapters and terminated with resistors. We recommend using off-the-shelf BNC cables to connect all devices, as this type of cable is used for most computer networks. You will find all the necessary components (T-adapters, terminators, cables) in most electronics and/or computer stores. The latter usually carries 50 Ohms components. The 75 Ohms components used for word clock are part of video technology (RG59).

Ideally, the word clock signal is a 5 Volt square wave with the frequency of the sample rate, of which the harmonics go up to far above 500 kHz. To avoid voltage loss and reflections, both the cable itself and the terminating resistor at the end of the chain should have an impedance of 75 Ohm. If the voltage is too low, synchronization will fail. High frequency reflection effects can cause both jitter and sync failure.

Unfortunately there are still devices on the market, even newer digital mixing consoles, which are supplied with a word clock output that can only be called unsatisfactory. If the output breaks down to 3 Volts when terminating with 75 Ohms, you have to take into account that a device, of which the input only works from 2.8 Volts and above, does not function correctly already after 3 meter cable length. So it is not astonishing that because of the higher voltage, word clock networks are in some cases more stable and reliable if cables are not terminated at all.

Ideally all outputs of word clock delivering devices are designed as low impedance types, but all word clock inputs as high impedance types, in order to not weaken the signal on the chain. But there are also negative examples, when the 75 Ohms are built into the device and cannot be switched off. In this case the network load is often 2 x 75 Ohms, and the user is forced to buy a special word clock distributor. Note that such a device is generally recommended for bigger studios.

The Fireface's word clock input can be high-impedance or terminated internally, ensuring maximum flexibility. If termination is necessary (e.g. because the Fireface is the last device in the chain), push the switch at the back beside the BNC socket (see chapter 22.1).

In case the Fireface UFX resides within a chain of devices receiving word clock, plug a T-adaptor into its BNC input jack, and the cable supplying the word clock signal to one end of the adaptor. Connect the free end to the next device in the chain via a further BNC cable. The last device in the chain should be terminated using another T-adaptor and a 75 Ohm resistor (available as short BNC plug). Of course devices with internal termination do not need T-adaptor and terminator plug.



Due to the outstanding SteadyClock technology of the Fireface UFX, it is recommended not to pass the input signal via T-adaptor, but to use the Fireface's word clock output instead. Thanks to SteadyClock, the input signal will both be freed from jitter and - in case of loss or drop out – be reset to a valid frequency.

22.4 Operation

The green Lock LED on the front (STATE) will light up as soon as a word clock signal is detected. To change to word clock as clock source, activate there Clock Source Word in the field Clock Mode within the Settings dialog. The status display *Current* changes to *Word* as soon as a valid signal is present at the BNC jack. This message has the same meaning as the green state LED, but appears on the monitor, i.e. the user can check immediately whether a valid word clock signal is present and is currently being used.

User's Guide



Fireface UFX

▶ Stand-Alone Operation

23. Operation and Usage

23.1 General

Using the three rotary encoders and the clear colour display the Fireface UFX can be configured and set up completely at the device. Additionally internal memory allows for the permanent storage of six different states of the unit. Therefore the Fireface UFX is able to operate fully stand-alone, without any connected computer. In stand-alone operation it can transform into totally different devices by the simple click of a button. Furthermore TotalMix, and with this the application examples shown below, can also be controlled via MIDI, see chapter 28.6, *Stand-Alone MIDI Control*.

23.2 Settings at the Unit

The Fireface UFX has a simple menu structure, depending on the button pressed.

MIC/GAINS. Mic.Instr. Gain 9/10, Mic.Instr. Gain 11/12. Setting the gain for the inputs 9 to 12.

METERS. Level meter for all inputs, outputs and FX send/return. Since firmware 1.34 this button changes between Record/Playback (Direct USB Recording) and the level meter display.

CHANNEL. Encoder 1 selects the input and output to be configured, encoder 2 selects the function to be configured. These are *Settings*, *Low Cut*, *Parametric EQ Compressor/Expander* and *Auto Level*. At the outputs an additional page is shown, Mix (Mix – Analog In, Mix – AES In, Mix – ADAT In). Mix gives access to the whole submix of the specific output. Any input routed to that output can be modified in level and panorama.

SETUP/REV. Encoder 1 selects Setups, Options and Reverb/Echo. Options has the subpages *Clock Options*, *HW Options/Diagnosis* and *Control Room Options*. Reverb/Echo has the subpages *Reverb* and *Echo*. The subpages are selected with encoder 2.

23.3 Store / Load Setups at the Unit

After hitting the key SETUP/REV, turning the encoder 1 changes to *Setups*. First select the preferred storage place, then the desired process (load or store). The load/store process is completed by pushing encoder 2 for more than one second.

23.4 Storing Setups from the Computer

Setups can also be loaded into the unit from the computer. As the Setups are usually generated at the computer the final step of transmission offers a convenient workflow. In TotalMix FX use *Options / Store current state into device* to select the desired storage place (Setup) within the unit.

24. Examples

24.1 12-Channel AD/DA-Converter

TotalMix' super-flexible routing functions make it easy to turn the UFX into a 12-channel AD/DA converter. It's easy to build the setup. For a clean start perform a *Total Reset* from the Options menu. Then select the ADAT Output 1/2 in the third row, and pull up the faders of the Analog input 1/2 in the first row. Then select ADAT 3/4, pull up Analog 3/4 and so on until all 12 analog inputs are routed to the corresponding 12 (8+4) ADAT channels. Now do the same for the analog outputs, route all ADAT inputs to these one after the other. A monitoring of all or selected I/Os can be easily set up for the AES output, or as analog mixdown on one of the phones outputs.

24.2 4-Channel Mic Preamp

Use TotalMix to route the four microphone inputs directly to the analog outputs. This turns the Fireface UFX into a 4-channel microphone preamp. The AD- and DA-conversion will cause a small delay of the signals of around 0.17 ms (at 192 kHz, see chapter 38.2). But this is nothing to worry about, as it is the same delay that would be caused by changing the microphone's position by about 5.6 centimeter (2 inches).

24.3 Monitor Mixer

TotalMix allows ANY configuration of all I/Os of the Fireface. For example, set up the device as monitor mixer for 12 analog signals, 16 digital via ADAT and 2 via AES. Additionally, TotalMix lets you set up ANY submixes, so all existing outputs can be used for different and independent monitorings of the input signals. The perfect headphone monitor mixer!

24.4 Digital Format Converter

As TotalMix allows for any routing of the input signals, the Fireface UFX can be used as ADAT to AES converter, ADAT to two ADAT splitter, and AES to ADAT converter.

24.5 Analog / Digital Routing Matrix

The Matrix in TotalMix enables you to route and link all inputs and outputs completely freely. All the above functionalities are even available simultaneously, can be mixed and combined in many ways. Simply said: the Fireface UFX is a perfect analog/digital routing matrix!

24.6 Stand-Alone Recorder/Player

The UFX can be used for recording as well as playback of audio signals. As all settings are available directly at the unit it is possible to record a live concert completely without a computer. Music copied that was copied to a USB stick before can be played back anytime. Of course both in combination to any of the other examples above!



User's Guide



Fireface UFX

▶ **TotalMix FX**

25. Routing and Monitoring

25.1 Overview

The Fireface UFX includes a powerful digital real-time mixer, the *Fireface UFX mixer*, based on RME's unique, sample-rate independent **TotalMix** technology. It allows for practically unlimited mixing and routing operations, with all inputs and playback channels simultaneously, to any hardware outputs. **TotalMix FX** adds 3-band parametric Equalizer, Low Cut, Echo, Reverb, Compressor, Expander and Auto Level.

Here are some typical applications for TotalMix:

- Setting up delay-free submixes (headphone mixes). The Fireface UFX allows for up to 15 fully independent stereo submixes. On an analog mixing desk, this would equal 30 Aux sends.
- Unlimited routing of inputs and outputs (free utilisation, patchbay functionality).
- Distributing signals to several outputs simultaneously. TotalMix offers state-of-the-art splitter and distributor functions.
- Simultaneous playback of different programs via a single stereo output. The ASIO multi-client driver supports the usage of several programs at the same time. If this happens on different playback channels TotalMix provides the means to mix and monitor these on a single stereo output.
- Mixing of the input signal to the playback signal (complete ASIO Direct Monitoring). RME is not only *the* pioneer of ADM, but also offers the most complete implementation of the ADM functions.
- Integration of external devices. Use TotalMix to insert external effects devices, be it in the playback or in the record path. Depending on the current application, the functionality equals insert or effects send and effects return, for example as used during real-time monitoring when adding some reverb to the vocals.

Every single input channel, playback channel and hardware output features a Peak and RMS level meter, calculated in hardware. These level displays are very useful to determine the presence and routing destinations of the audio signals.

For a better understanding of the TotalMix mixer you should know the following:

- As shown in the block diagram (next page), the record signal usually stays un-altered. TotalMix does not reside within the record path, and does not change the record level or the audio data to be recorded (exceptions: *EQ+D for Record* and *Loopback* mode).
- The hardware input signal can be passed on as often as desired, even with different levels. This is a big difference to conventional mixing desks, where the channel fader always controls the level for all routing destinations simultaneously.
- The level meters of input and playback channels are connected pre-fader, to be able to visually monitor where a signal is currently present. The level meters of the hardware outputs are connected post-fader, thus displaying the actual output level.

RME TotalMix FX
Fireface UFX
Mixer Overview
Block Diagram, 09/2010

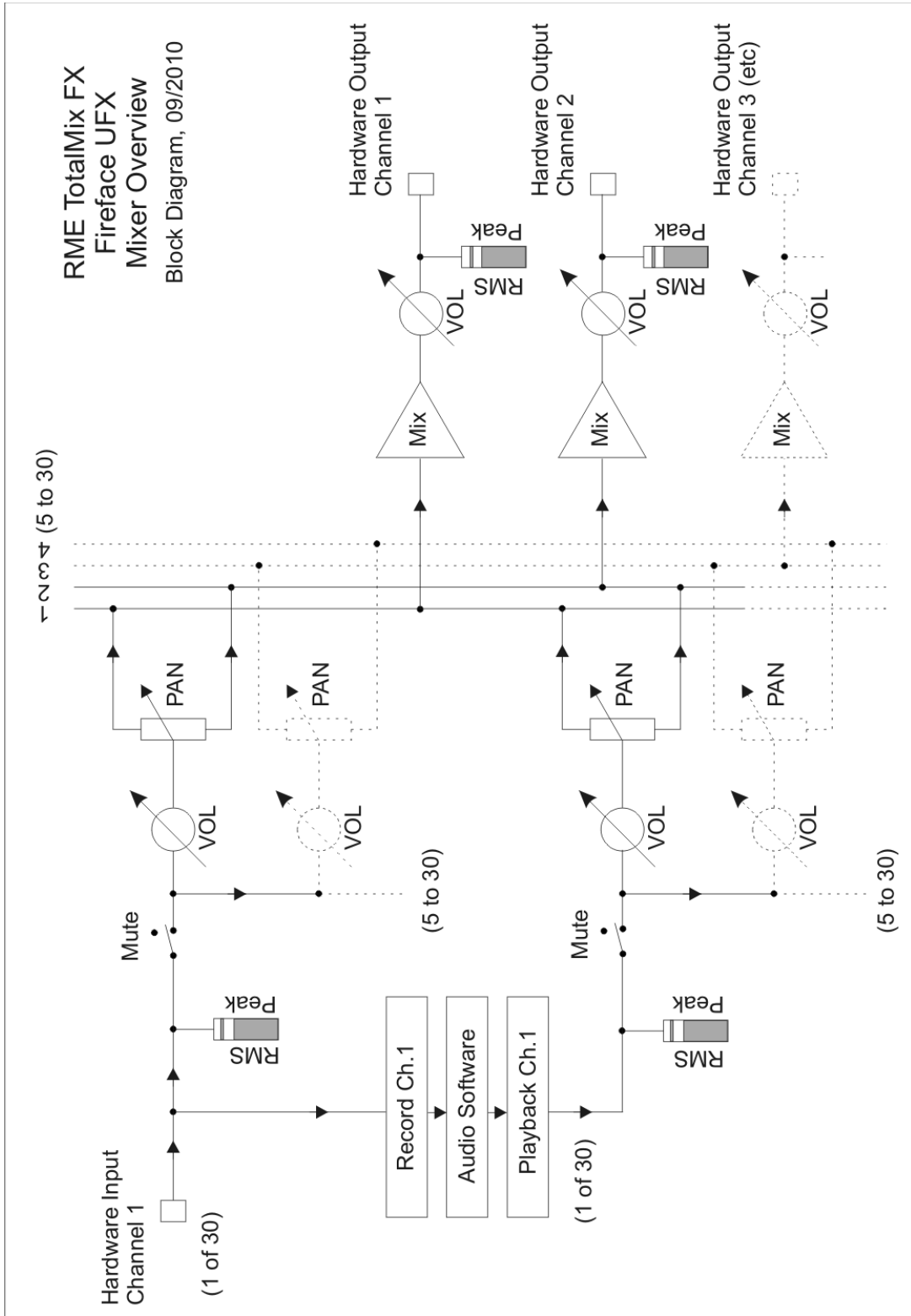

25.2 The User Interface

The visual design of the TotalMix mixer is a result of its capability to route hardware inputs and software playback channels to any hardware output. The Fireface UFX has 30 input channels, 30 software playback channels, and 30 hardware output channels:

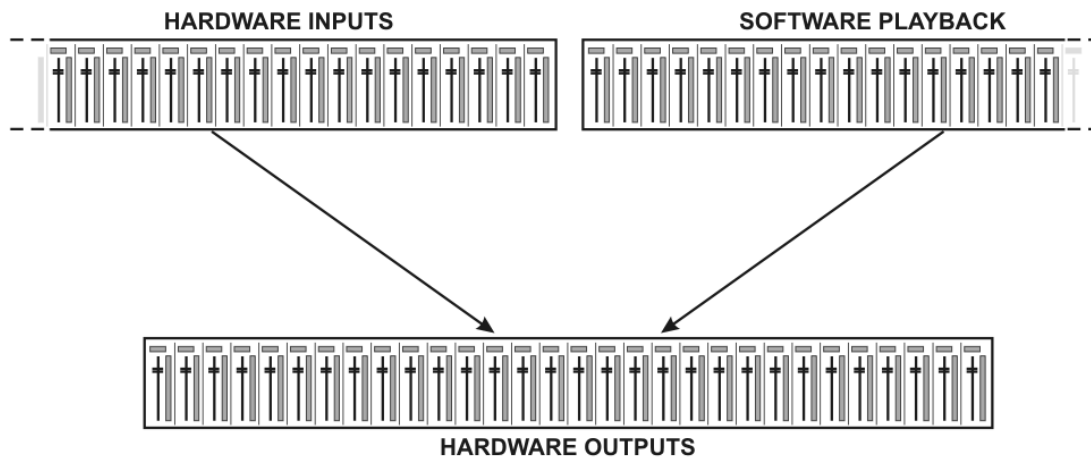

TotalMix can be used in the above view (View Options **2 Rows**). However, the default is a vertical alignment in three rows as known from an Inline desk, so that the row *Software Playback* equals the *Tape Return* of a real mixing desk:

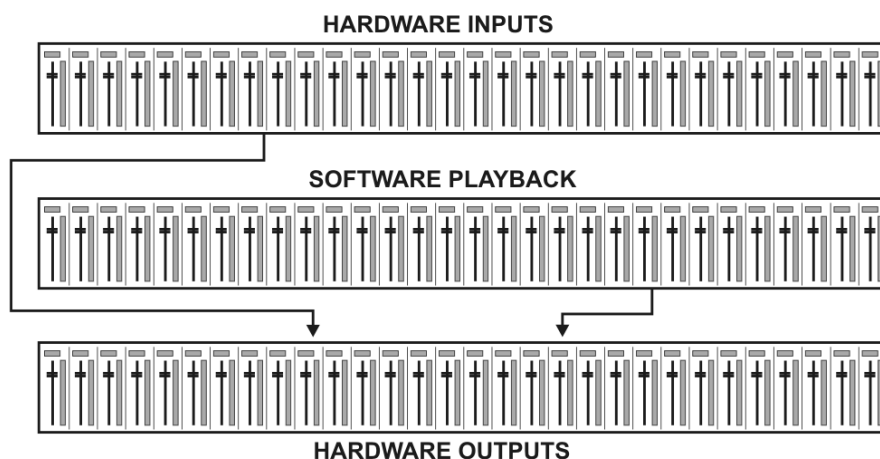

- Top row: Hardware inputs. The level shown is that of the input signal, i.e. fader independent. Via fader and routing menu, any input channel can be routed and mixed to any hardware output (bottom row).
- Middle row: Playback channels (playback tracks of the audio software). Via fader and routing menu, any playback channel can be routed and mixed to any hardware output (bottom row).
- Bottom row: Hardware outputs. Here, the total level of the output can be adjusted. This may be the level of connected loudspeakers, or the level of any submix.

Usage in mode Submix View (Default): simply click on the hardware output channel where you want to have an audio signal. This channel turns brighter, means it is selected as current submix. Now move the faders up from all sources - input and playback channels - that you want to hear at the submix output.

The following chapters explain step by step all functions of the user interface.

25.3 The Channels

A single channel can be switched between mono and stereo mode. The mode is set in the channel settings.

Channel name. The name field is the preferred place to select a channel by a mouse click. A double click opens a dialog to assign a different name. The original name will be shown when activating the option *Names* in the View Options.

Panorama. Routes the input signal freely to the left and right routing destination (lower label, see below). The level reduction in center position is -3 dB.

Mute and Solo. Input channels and playback channels each have a mute and solo button.

Numerical level display. Shows the current RMS or Peak level, updated twice per second. OVR means overload. The setting Peak/RMS is changed in the View Options.

Level meter. The meter shows both peak values (zero attack, 1 sample is enough for a full scale display) by means of a yellow line, and mathematically correct RMS values by means of a green bar. The RMS display has a relatively slow time constant, so that it shows the average loudness quite well. Overs are shown in red at the top of the bar. In the Preferences dialog (F2) the Peak Hold time, the over detection and the RMS reference can be set.



Fader. Determines the gain/level of the signal routed to the current routing destination (lower label). Please note that this fader is not *the* fader of the channel, but only the fader of the current routing. Compared to a standard mixing desk TotalMix does not have a channel fader, but only Aux Sends, as many as there are hardware outputs. Therefore TotalMix can create as many different Submixes as there are hardware outputs. This concept is understood best in the Submix View, but more on that later.

Below the fader the **Gain** is shown in a numerical display field, according to the current fader position. The fader can be:

- dragged with the left mouse button pressed
- moved by the mouse wheel
- set to 0 dB and $-\infty$ by a double click. The same happens with a single click plus held down Ctrl key.
- adjusted in fine mode by mouse drag and mouse wheel when holding the Shift key down

A Shift-click on a fader adds the fader to the **temporary fader group**. All faders now marked yellow are ganged, and move simultaneously in a relative way. The temporary fader group is deleted by a click on the F symbol in the upper right of the window.



The **arrow symbol** at the bottom minimizes the channel width to that of the level meters. Another click maximizes it again. A mouse click with held Ctrl key causes all channels to the right to enlarge and minimize at once.

The lowest field shows the current **routing target**. A mouse click opens the routing window to select a routing target. The list shows all activated routings of the current channel by arrows in front of the listed entries, the current one is shown in bold letters.

An arrow is only shown with an activated routing. A routing is seen as activated when audio data is sent. As long as the fader is set to $-\infty$ the current routing will be shown in bold letters, but not have an arrow in the front.



Trim Gain. After a click on the T-button one channel's faders are all synchronized. Instead of changing only a single routing the fader affects all the channel's active routings. For a better overview the faders currently not visible are indicated by orange triangles beside the fader path. When moving the fader the triangles also move to a new position, equalling the invisible faders' new settings.

Note that the fader button is automatically set to the highest routing gain of all routings so that best control is offered. The gain (fader knob position) of the currently active routing (the submix selected in the third row) is shown as white triangle.

Background: TotalMix has no fixed channel fader. In case of the Fireface UFX there are 15 stereo Aux sends, shown alternately as single fader within the channel strip. The high number of Aux sends enables multiple and fully independent routings.

In some cases it is necessary to synchronize the gain changes of these routings. An example is the Post fader function, where a change of the singer's volume shall be performed identical to the volume change of the signal sent to the reverb device, so that the reverb level keeps its relation to the original signal. Another example is the signal of a guitar that is routed to different submixes, means hardware outputs, which gets much too loud during the solo part, and therefore needs to be reduced in volume on all outputs simultaneously. After a click on the Trim button this can be done easily and with a perfect overview.

As all channel's routings change simultaneously when Trim is active, this mode basically causes the same behaviour as a trim pot within the input channel, affecting the signal already before the mixer. That's how this function got its name.



In the *View Options / Show* the function Trim Gains can be globally switched on and off for all channels. The global Trim mode is recommended when using TotalMix FX as live mixing desk.

The Context Menu. With a right click on the input, playback and output channels their context menus provide advanced functionality (these menus are also available in the Matrix, but only directly on the channel labels). The entries are self-explanatory and automatically adjust to where the click is performed. The input channels offer *Clear*, *Copy input*, *paste the input mix* and *paste its FX*. On a playback channel *Copy*, *Paste* and *Clear the playback mix* are available. On an output channel *Copy* and *Mirror* functionality for the current submix and *copying* of the FX settings is offered.

25.3.1 Settings

A click on the tool symbol opens the channel's **Settings** panel with differing elements. For example the option **Inst** exists only in input channels 9-12, and the ADAT channels do not offer the phantom power option.

Stereo. Switches the channel to mono or stereo mode.

48V. Activates phantom power at the corresponding input. Serves as power supply for high quality condenser mics. This option should stay off with other sources to prevent failure by spikes.

Inst. Switches inputs 9 to 12 individually from XLR to the TRS jack.

Gain. Sets the gain for the four front inputs. The knob can be adjusted by dragging the mouse or by the mouse wheel. This also works when the mouse has been moved over the two gain displays. Then the gain can be changed separately for left and right channel, even when the channel is in stereo mode.

Level. Sets the reference level individually for the 8 rear Line inputs. The available settings are -10 dBV, +4 dBu and LoGain.

AutoSet. Activates an automatic gain reduction preventing overloads caused by too high gain settings. See chapter 19.2 for details.

Width. Defines the stereo width. 1.00 equals full stereo, 0.00 mono, -1.00 swapped channels.

FX Send. Setting the level of the signal sent to the FX bus which feeds Echo and Reverb. The current setting is also visible with closed channel settings, because knob and small fader are always synchronized. To make this function as useful as possible FX Send is locked to the highest submix, thus imitating the *Aux Post Fader* function of a standard mixing desk. When moving the big fader both knob and small fader will also move. This way the reverb signal will always have the same relation to the dry signal.

The level of the signal sent to the effects can be controlled by the *FX In* level meters of the FX window. It becomes visible after a click on FX in the View Options.

MS Proc. Activates M/S processing within the stereo channel. Monaural information is sent to the left channel, stereo information to the right.

Phase L. Inverts the phase of the left channel by 180°.

Phase R. Inverts the phase of the right channel by 180°.

Note: the functions Width, MS Proc, Phase L and Phase R affect all routings of the respective channel.



Besides Stereo/Mono, Phase L und Phase R the settings of the Hardware Outputs have further options:

Level. Sets the reference levels of the 8 analog Line outputs. The available settings are -10 dBV, +4 dBu and HiGain. The outputs 1/2 additionally offer +24 dBu. The Phones (channels 9-12) have a Low and High setting to choose from.

FX Return. The effect signal (Echo and Reverb) is mixed to the respective hardware output by the duo knob/small fader.

Talkback. Activates this channel as receiver and output of the Talkback signal. This way Talkback can be sent to any outputs, not only the Phones in the Control Room section. Another application could be to send a certain signal to specific outputs by the push of a button.

No Trim. Sometimes channels need to have a fixed routing and level, which should not be changed in any case. An example is the stereo mixdown for recording of a live show. With *No Trim* active, the routing to this output channel is excluded from the Trim Gains function, therefore is not changed unintentionally.



Loopback. Sends the output data to the driver as record data. The corresponding submix can be recorded then. This channel's hardware input sends its data only to TotalMix, no longer to the recording software.

Another difference to the input and playback channels is the **Cue** button instead of Solo. A click on Cue sends the respective Hardware Output's audio to the **Main** Out, or any of the Phones outputs (option *Assign / Cue to* in the Control Room section). With this any hardware output can be controlled and listened to through the monitoring output very conveniently.

25.3.2 Equalizer

A click on EQ opens the **Equalizer** panel. It is available in all input and output channels, and affects all routings of the respective channel (pre fader). The panel includes a low cut and a 3-band parametric equalizer which can be activated separately.

EQ. Activated by the EQ button.

Type. Band 1 and 3 can operate in peak (bell) or shelf (shelving) mode. The middle band is fixed to peak mode. Band 3 can also operate as *Hi Cut* (low pass filter), especially useful for LFE and subwoofer purposes.

Gain. All three bands can change their amplification between +20 dB to -20 dB.

Freq. The center frequency of the filters is adjustable between 20 Hz and 20 kHz. While in peak mode the center frequency is adjusted, in shelf mode the cut-off point (-3 dB) will be changed.

Q. The Quality factor of the filter is adjustable from 0.7 (wide) to 5.0 (narrow).



Lo Cut. Activated by the button Lo Cut. The slope of the high-pass filter is adjustable between 6, 12, 18 and 24 dB per octave. The cut-off point (-3 dB) is adjustable between 20 Hz and 500 Hz.

The frequency graphics give a precise overview of the filter results. Overlapping filters influence each other. This can be used to achieve more than 20 dB amplitude, or to generate difficult frequency response optimizations.

Note: TotalMix has an internal headroom of 24 dB. Extreme boosts with overlapping filters can therefore cause an internal overload. In any case such an overload is displayed by the Over LED of the channel's level meter.

Preset. Settings of the EQ and the Low Cut can be stored, loaded, and copied between channels at any time. A click on Preset opens a menu with several entries:

- **Recall:** Presets stored before by the user can be selected and loaded
- **Save to:** There are 16 storage places available (EQ Preset 1 to 16)
- **Import:** Loads a previously stored TM EQ file (.tmeq)
- **Export:** Stores the current state as TM EQ file (.tmeq)
- **Factory:** Includes 14 examples for the creative use of Low Cut and Equalizer
- **Reset:** Resets the Low Cut and EQ to have zero influence (Gain 0 dB)
- **Rename:** The EQ Presets 1 to 16 can be renamed. The changes will be shown in both lists Recall and Save to.

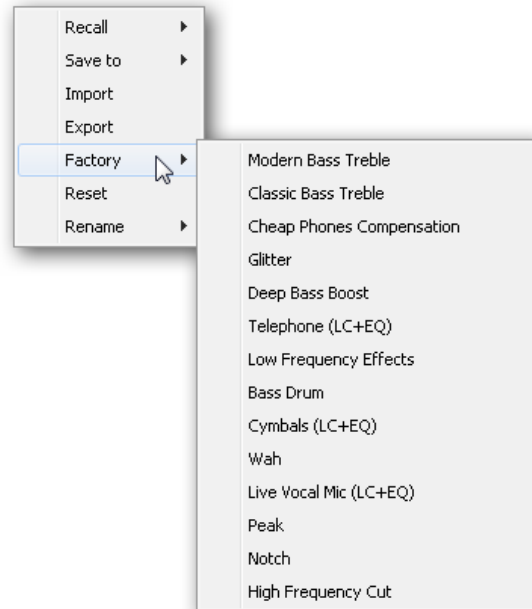

Notes on the EQ Presets

Copy between channels: The EQ Preset menu of all channels is identical. If an EQ setup is stored via *Save to* on one of the 16 storage places, it is then also available in any other channel via *Recall*.

Copy between Snapshots: The Presets are not saved in Snapshots, therefore do not change when a different Snapshot is loaded. Presets are saved in Workspaces and also loaded with these.

Copy between Workspaces: is done by the export and import function of the Preset menu. Important and useful Presets should always be saved as TM EQ file, so that they can not get lost even on accidental overwrite.

Factory Presets: loaded like all Presets the settings of both Low Cut and EQ simultaneously. The current state, On or Off, is neither saved nor activated on load. With this a preset can be loaded anytime, but will not become active before the user decides to switch the EQ and/or LC on – except they had been active already before the load process. For this reason some Factory Presets have special names. For example Telephone (LC+EQ) will sound much better when the LC has been activated additionally to the EQ, as the LC is set to an unusual high frequency of 500 Hz here.

25.3.3 Dynamics

A click on D opens the **Dynamics** panel with Compressor, Expander and Auto Level. They are available in all input and output channels, and affects all routings of the respective channel.

Dynamics. Activated by this button.

Thresh. Threshold where Compressor or Expander start to work. The Compressor is adjustable from -60 dB to 0 dB, the Expander is adjustable from -99 dB to -20 dB.

Ratio. Ratio of input to output signal. Defines the intensity of the signal processing. Adjustable from 1 to 10.

Gain. Gain stage to compensate a loss in level caused by the Compressor. Adjustable from -30 to +30 dB. With inactive Compressor (Threshold 0 dB, Gain 1:1) this function can also be used as universal digital gain stage.

Attack. Defines the rise time for the control voltage of Compressor/Expander. Adjustable from 0 ms to 200 ms.

Release. Defines the release time for the control voltage of Compressor and Expander. Adjustable from 100 ms to 999 ms.



The amplitude graphics give a precise overview of the level changes caused by the current settings of Compressor and Expander. The white dot shows the level of the input signal and with this whether the signal is within the processing range or not. The small light blue lines in the level meter show the currently active gain reduction. Settings for these *Dynamic Meters* are found in the Preferences dialog (F2).

Auto Level. Activated by this button.

Max. Gain. Defines the maximum amplification of the input signal. Adjustable from 0 dB to 18 dB.

Headroom. To minimize short-time overloads and clipping of the signal peaks Auto Level can be set to operate at a fixed offset to 0 dBFS. Adjustable from 3 dB to 12 dB.

Rise Time. Defines the speed of a level increase after a level reduction. Adjustable from 0.1 s to 9.9 s.

Preset. Includes the same functions as described on the previous page for the Equalizer. The names of the Factory Presets make clear whether Compressor, Auto Level or both (C+A) have to be switched on.

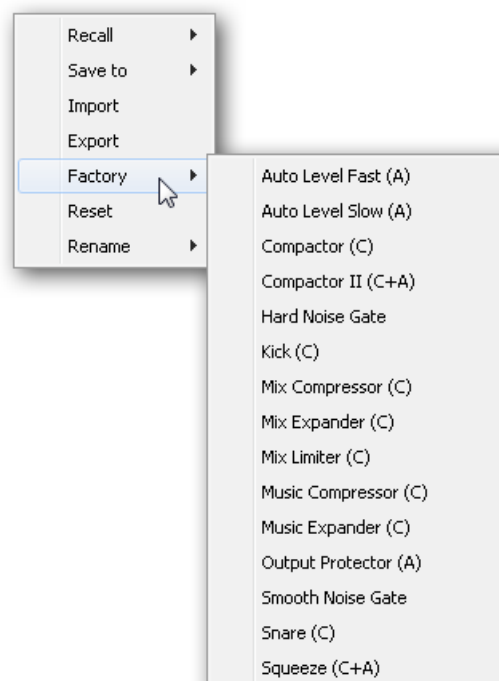

25.4 Section Control Room

In the section Control Room the menu *Assign* defines the **Main Out** which is used for listening in the studio. For this output the functions Dim, Recall, Mono, Talkback, External In and Mute FX are automatically applied. At the unit the VOLUME knob follows this assignment.

Additionally the channel will be shifted from the Hardware Outputs into the Control Room section, and renamed *Main*. The same happens when assigning Main Out B or the Phones. The original name can be displayed by the function *Names* in the View Options at any time.

Phones 1 to 4 will have Dim (set in Settings) and a special routing applied when Talkback is activated. Putting them beside the Main Out increases the overview within the output section greatly.

Note: Phones 1 to 4 can be freely assigned in TotalMix FX. As the Phones outputs on the unit are dedicated outputs with channels 9 to 12, these channels are also fixed for operation at the unit. So pushing the VOLUME button will step through Main Out (free), Phones 1 (with channels 9/10) and Phones 2 (with channels 11/12), no matter which channels have been selected for Phones in TotalMix FX.



Dim. The volume will be reduced by the amount set in the Settings dialog (F3).

Recall. Sets the gain value defined in the Settings dialog.

Speaker B. Switches playback from Main Out to Main Out B. The faders of the channels Main and Speaker B can be ganged via Link.

Mono. Mixes left and right channel. Useful to check for mono compatibility and phase problems.

Talkback. A click on this button will dim all signals on the *Phones* outputs by an amount set up in the Preferences dialog. At the same time the control room's microphone signal (source defined in Preferences) is sent to the *Phones*. The microphone level is adjusted with the channel's input fader.

External Input. Switches Main monitoring from the mix bus to the stereo input defined in the Settings dialog (F3). The relative volume of the stereo signal is adjusted there as well.

Mute FX. Mutes Reverb and Echo on the Main Out, to hear the mix without those effects.

Assign. Allows to define the Main Out, Main Out B (Speaker B), and up to four Phones outs.

The output for the Cue signal, which is usually Main, can also be set to one of the Phones outputs. This setting also controls the PFL monitoring.

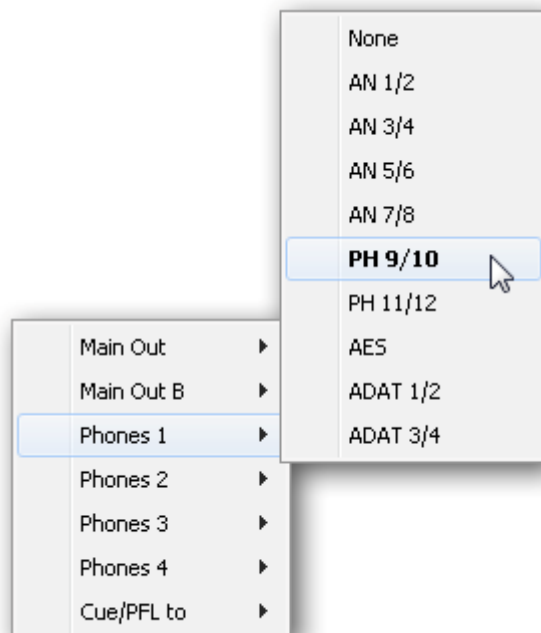

25.5 The Control Strip

The Control Strip on the right side is a fixed element. It combines different functions that are either required globally, or constantly used, and therefore should not be hidden in a menu. It can still be hidden via the top menu Window – Hide Control Strip.

The areas described in the following chapters can be minimized by a click on the arrow in their title bar.

Device selection. Select the unit to be controlled in case more than one is installed on the computer.

FX - DSP Meter. Shows the DSP load caused by activated EQ, Low Cut, Compressor, Auto Level, Echo and Reverb. The DSP of the Fireface UFX has an automatic load limiter. If no DSP resources are left further effects can not be activated. When switching to DS and QS modes effects will be deactivated automatically until the DSP is not overloaded anymore.

Undo / Redo. With the unlimited Undo and Redo changes of the mix can be undone and redone, at any time. Undo/Redo does not cover graphical changes (window size, position, channels wide/narrow etc.), and also no changes to the Presets. The accidental overwrite of an EQ Preset can not be made undone.

Undo/Redo also operates across Workspaces. Therefore a completely differently set up mixer view can be loaded via Workspace, and with a single click on Undo the previous internal mixer state is returned – but the new mixer view stays.

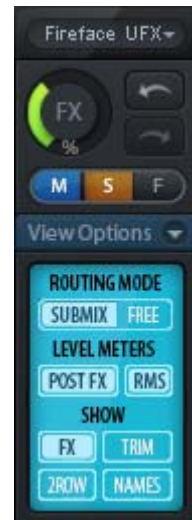

Global Mute - Solo - Fader.

Mute. Global Mute operates in a pre fader style, muting all currently activated routings of the channel. As soon as any Mute button is pressed, the *Mute Master* button lights up in the Control Strip area. With this button all selected mutes can be switched off and on again. One can comfortably set up a mute group or activate and deactivate several mute buttons simultaneously.

Solo. As soon as any Solo button is pressed, the *Solo Master* button lights up in the Control Strip area. With this button all selected Solos are switched off and on again. Solo operates as Solo-in-Place, post fader style, as known from common mixing desks. A typical limitation for mixing desks, Solo working only globally and only for the Main Out, does not exist in TotalMix. Solo is always activated for the current submix only.

Fader. A Shift-click on a fader adds the fader to the **temporary fader group**. All faders now marked yellow are ganged, and move simultaneously in a relative way. The temporary fader group is deleted by a click on the F symbol.

25.5.1 View Options

The field **Show** combines different functions of routing, the level meters and the mixer view.

Routing Mode

- **Submix.** The Submix view (default) is the preferred view and delivers the quickest overview, operation and understanding of TotalMix. The click on one of the Hardware Output channels selects the respective submix, all other outputs are darkened. At the same time all routing fields are set to this channel. With Submix view, it is very easy to generate a submix for any output: select the output channel, adjust the fader and pans of first and second row – finished.
- **Free.** The Free view is for advanced users. It is used to edit several submixes simultaneously, without the need to change between them. Here one works with the routings fields of the input and playback channels only, which then show different routing destinations.



Level Meters

- **Post FX.** Switches all level meters before (pre) or after (post) the effects. Level changes by these can be easily checked using this feature. Additionally the input signal can be checked for overloads. It is recommended to use Post FX as default setting, as the extreme reduction of a signal by LC/EQ is very seldom. Also all over displays of all level meters operate both pre and post, efficiently preventing overloads going unnoticed.
- **RMS.** The numerical level display in the channels displays peak or RMS.

Show

- **FX.** Opens the window to set up the effects Reverb and Echo.
- **Trim.** Activates all Trim buttons on all channels. TotalMix thus behaves like a conventional, simple mixing desk. Each fader affects all active routings of the channel simultaneously, as if the fader were a trim-pot in the hardware input.
- **2 Row.** Switches the mixer view to 2 rows. Hardware Inputs and Software Playbacks are placed side by side. This view saves a lot of space, especially in height.
- **Names.** Display of the original names of channels when they had been renamed by the user.

25.5.2 Snapshots - Groups

Snapshots. Snapshots include all mixer settings, but no graphical elements like window positions, window size, number of windows, visible EQs or Settings, scroll states, Presets etc. Only the state wide/narrow of the channels is registered. Moreover the Snapshot is only temporarily stored. Loading a Workspace causes the loss of all stored Snapshots, when these all had not been saved before in a Workspace, or separately via *File / Save Snapshot as*. Via *File / Load Snapshot* the mixer states can be loaded individually.

Eight different mixes can be stored under individual names in the Snapshot section. A click on any of the eight buttons loads the corresponding Snapshot. A double click on the name field opens the dialog *Input Name* to edit the name. As soon as the mixer state is changed the button starts flashing. A click on Store lets all buttons flash, whereby the last loaded one, the base of the current state, flashes inversely. The storage finishes by clicking the desired button (means storage place). The storage process is exited by another click on the flashing Store button.

The area Snapshots can be minimized by a click on the arrow in the title bar.

Groups. The area Groups provides 4 storage places each for fader, mute and solo groups. The groups are valid per Workspace, being active and usable in all 8 Snapshots. But with this they are also lost when loading a new workspace, in case they have not been saved before in a different Workspace.

Note: The Undo function will help in case of an accidental overwrite or deletion of the groups.

TotalMix uses flashing signals to guide you through the group setup. After a click on Edit and click on the desired storage place all desired functions for this group have to be activated or selected. The storage process is finished by another click on Edit.

When setting up a fader group make sure to not add faders that are at the top or low position, unless all faders of that group have this position.

The Mute groups operate – other than the global mute – exclusively for the current routing. This way you can not mute signals on all outputs unintentionally. Instead signals can be muted on specific submixes by the push of a button.

A solo group operates exactly like the global solo, signals outside the current routing are not affected.

25.5.3 Channel Layout - Layout Presets

To maintain overview within TotalMix FX channels can be hidden. Channels can also be excluded from being remoted. Under *Options / Channel Layout* a dialog lists all I/Os with their current state. Selecting one or several channels enables the options to the right:

- **Hide Channel in Mixer/Matrix.** The selected channels are no longer shown in TotalMix FX, nor are they available via MIDI or OSC remote control.
- **Hide Channel in MIDI Remote 1-4.** The selected channels are hidden for MIDI remote (CC and Mackie Protocol).
- **Hide Channel in OSC Remote 1-4.** The selected channels are hidden for OSC remote control.

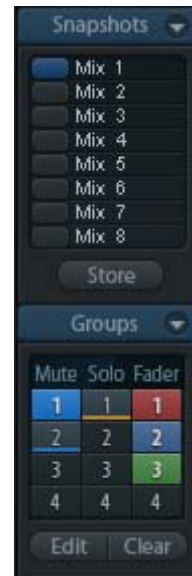

Hidden channels in Mixer/Matrix are still fully functional. An existing routing/mixing/FX processing stays active. But as the channel is no longer visible it can not be edited anymore. At the same time the hidden channels are removed from the list of remote controllable channels, to prevent them from being edited unnoticed.

Hidden channels in *MIDI Remote x* are removed from the list of remote controllable channels. Within an 8-channel block of a Mackie compatible control they are skipped. The control therefore is no longer bound to consecutive orders. For example it will control channels 1, 2, and 6 to 11, when channels 3 to 5 are hidden.

The same can be done for OSC. With unnecessary channels made invisible for the OSC remote the more important channels are available as one block on the remote.

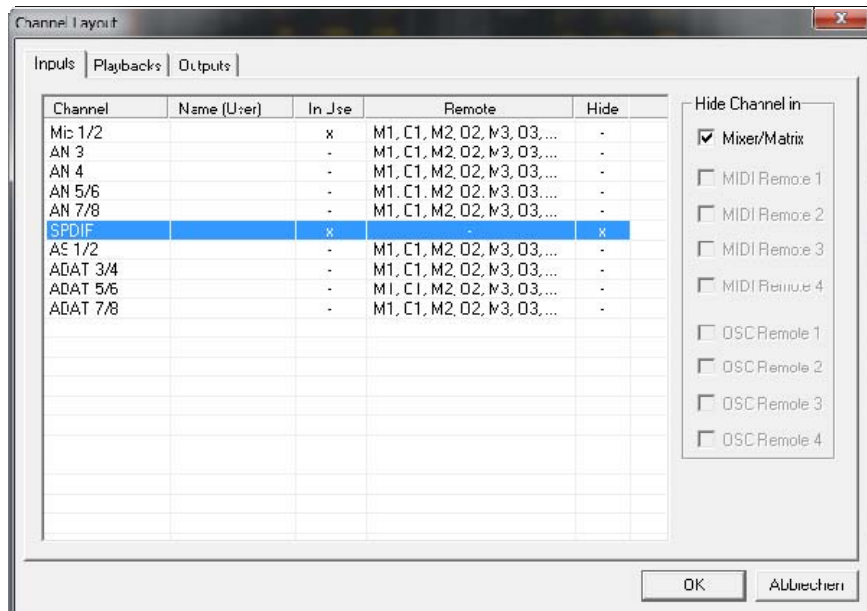

The dialog can be called directly from TotalMix by a right mouse click on any channel. The corresponding channel will then be preselected in the dialog.

Rows Inputs, Playbacks and Outputs are set up individually by the tabs at the top. *In Use* shows which channels are currently used in the mixing process.

In the above example the SPDIF input channel has been made invisible. When SPDIF is not used this is an easy way to remove it from the mixer completely. A more complex setup would be to only show all channels of the drum section, the horn section or the violins.

After finishing those settings the whole state can be stored as **Layout Preset**. A click on *Store* and the desired memory slot makes the current channel layout recallable anytime. The button *All* makes all channels temporarily visible again.

With a simple click on a button it will then be possible to easily switch views of only the channels involved with the mixing of the drum section, the horn section, the violins, or any other useful view. An optimized remote layout can be activated here as well, with or without visible changes. Double-click the default slot name to enter any other name.



 *Layout Presets are stored within the Workspace, so make sure to save the current state before loading a different Workspace!*

The button *Sub* activates another useful special view. When in *Submix view*, *Sub* will cause all channels to disappear that are not part of the currently selected Submix/Hardware Output. *Sub* temporarily shows the mix based on all channels from Inputs and Playback row, independent from the current Layout Preset. That makes it very easy to see and to verify which channels are mixed/routed to the current output. *Sub* makes checking and verifying of mixes, but also the mix editing itself, a lot easier, and maintains perfect overview even with lots of channels.

25.5.4 Scroll Location Markers

Another feature to improve overview and working with TotalMix FX are scroll location markers (TotalMix view only). These are displayed automatically when the horizontal size of the TotalMix FX window is smaller than the channel display requires. Shown on the right side of the scrollbar of each row they have four elements:

- **Arrow to the left.** A left mouse click let the channels scroll to the very first one, or most left.
- **1.** Marker number 1. Scroll to the desired position and perform a right mouse click on 1. A dialog comes up with precise information. Once stored, a left mouse click will scroll the channels to the stored position.
- **2.** Marker number 2. See 1 for details.
- **Arrow to the right.** A left mouse click let the channels scroll the last one, or most right.



Location markers are stored in the Workspace.

Application Examples

While originally added to improve navigation in the HDSPe MADI FX (having 196 channels that never fit on any screen), the scroll location markers are also helpful with units having much less channels:

- When the TotalMix FX window is intentionally made small in width, so only a few channels are shown.
- When some or all EQ or Dynamics panels are open. Then all relevant settings are always visible, but require a lot of space horizontally.

25.6 Reverb and Echo

A click on FX in the *View Options / Show* brings up the Output FX panel. Here all parameters for the effects Reverb and Echo are adjusted.

Reverb. Activated by the On button.

Type. Lists different reverb types for selection. Available are:

- **Rooms Small, Medium, Large, Walls.** Room simulation of rooms in different size and behaviour.
- **Shorty** provides a short, rich and warm reverb.
- **Attack** slaps back.
- **Swagger** enriches and blows up the original sound source.
- **Old School** is just that.
- **Echoistic** has a heavy echo part within the reverb sound which brings some nice stereo effect as well.
- **8plus9** is a mixture of Old School and Echoistic.
- **Grand Wide** stands for a wide and open room and space.
- **Thicker** can be used as short reverb to enrich the original signal.
- **Space** has the most sizzle and longest reverb time.
- **Envelope.** Reverb effect where the volume course (envelope) is freely adjustable.
- **Gated.** Simpler version of the Envelope reverb for cut reverb effects.

Please note that all these reverb types are extremely flexible due to the available Smooth and Room Scale controls. Most of them can be used as short and long reverb, and sound totally different with Smooth turned to maximum or minimum.

TotalMix FX comes with factory presets and default values for all reverb types to ensure a fast setup time and quick results. Please take the time to experiment with them with different signals and different settings, to learn how different they can sound and can be used.



General Settings

PreDelay. Delay of the reverb signal. Adjustable from 0 ms up to 999 ms.

Low Cut. High-pass filter *before* the reverb generation, removes low frequency signals which should not cause a reverb sound. Adjustable from 20 Hz up to 500 Hz.

High Cut. Low-pass filter *after* the reverb generation. A reduction of the treble often lets the reverb sound more natural. Adjustable from 5 kHz up to 20 kHz.

Smooth. Softens the reverb effect, affects stereo width, density and sound colour. Adjustable from 0 up to 100.

Width. Adjusts the stereo width of the reverb signal from 100 (stereo) to 0 (mono).

Volume. Adjusts the level of the reverb effects signal sent to the FX return bus.

Special Settings for Room Types

Room Scale. Determines the size of the room, thus changing density and length of the reverb effect. Adjustable from 0.5 up to 3.0.

Special Settings for Envelope and Gated

Attack. Length of time for the volume increase of the reverb signal. Also called rise time. Adjustable from 5 ms up to 400 ms.

Hold. Length of time for the fixed volume part of the reverb signal. Adjustable from 5 ms up to 400 ms.

Release. Length of time for the volume decrease of the reverb signal. Adjustable from 5 ms up to 400 ms.

Special Settings for Space

Reverb Time. Sets the duration of the reverb referenced to a volume drop of 20 dB. Adjustable from 0.1 s up to 4.9 s.

High Damp. Sets the treble damping over time for the reverb signal. In principle, this is a low-pass filter like High Cut. Because of the operation principle of this reverb it shows a slightly different behaviour. Adjustable from 5 kHz up to 20 kHz.

Echo. Activated by the On button.

Type. Lists different echo algorithms for selection. Available are:

- **Stereo Echo.** Separated echo generators on left and right channel. As a result the echo follows the sound source within the stereo field.
- **Stereo Cross.** Echo generator on left and right channel with cross coupled feedback which is only working for the stereo parts of the input signal. In case the input signal is only left or right the Stereo Cross acts exactly like the Pong Echo.
- **Pong Echo.** Generates an echo that jumps between left and right channel, independent from the source signal's stereo position.

Settings

Delay Time. Sets the delay time for the first echo.

BPM. A double click on the lower value field offers a delay adjustment as *Beats Per Minute*.

Feedback. Feedback to produce further echoes.

Width. Adjusts the stereo width of the echo signal from 100 (stereo) to 0 (mono).

Volume. Adjusts the level of the echo effects signal sent to the FX return bus.

High Cut (HC). Option for more natural sound or intentional damping of the delayed signal.

Preset. Settings of the Reverb and the Echo can be stored, loaded, and copied between channels at any time. A click on Preset opens a menu with several entries:

- **Recall:** Presets stored before by the user can be selected and loaded
- **Save to:** There are 16 storage places available (Reverb/Echo Preset 1 to 16)
- **Import:** Loads a previously stored TM FX Reverb file (.tmrv) or a TM FX Echo file (.tmeo)
- **Export:** Stores the current state as TM FX Reverb file (.tmrv) or as TM FX Echo file (.tmeo)
- **Factory:** Includes 10 examples for the configuration of the Reverb
- **Reset:** Resets the Reverb or Echo
- **Rename:** The Presets 1 to 16 can be renamed. The changes will be shown in both lists Recall and Save to.

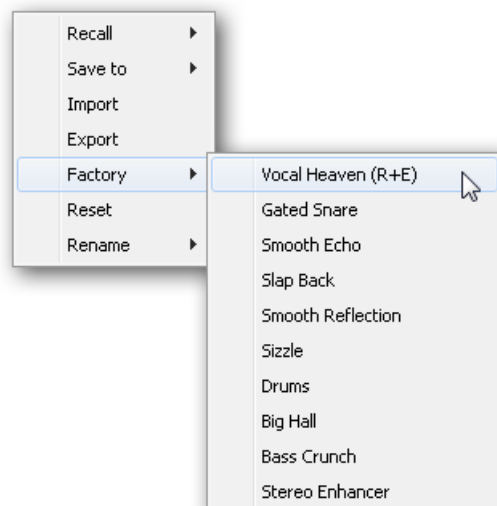

25.7 Preferences

The dialog Preferences can be opened via the *Options* menu or directly via F2.

Level Meters

- **Full scale samples for OVR.** Number of consecutive samples to trigger an over detection (1 to 10).
- **Peak Hold Time.** Hold time of the peak value. Adjustable from 0.1 up to 9.9 s.
- **RMS +3 dB.** Shifts the RMS value by +3 dB, so that full scale level is identical for Peak and RMS at 0 dBFS.

Mixer Views

- **FX Send follows highest Submix.** Locks the FX Send knob to the channel fader. As TotalMix supports multiple routings per channel, a definition is needed which fader (only one is visible) is the one that FX Send will follow. This is always the one with the highest fader position, means the highest gain.
- **FX Send follows Main Out.** Locks the FX Send knob to the channel fader only for the Main Out submix. This is a typical Live feature, where the FX Send is always tied to the fader for the most important output - the Main Out. When adjusting other submixes the FX send will not follow the fader movement.
- **Center Balance/Pan when changing Mono/Stereo.** When switching a stereo channel into two mono channels the pan-pots are set fully left and right. This option will set them to center instead.
- **Disable double click fader action.** Prevents unintentional gain settings, for example when using sensitive touchpads.

Dynamic Meters

- **Compressor/Expander.** Activates the display of the Compressor/Expander's gain reduction as thin blue line in the level meters of the corresponding channel.
- **Include Gain setting.** The currently set fixed amplification value (by the Gain knob) is included in the display. This can lead to positive values, with the display limited to +6 dB. In case the option Compressor/Expander is deactivated this option is also not available, therefore grayed out.
- **Auto Level.** Activates the display of the variable amplification of the Auto Leveler. As Auto Level can both amplify and attenuate the audio signal, depending on its configuration, the display can show negative (typical gain reduction) as well as positive (above 0 dB, amplification) values.

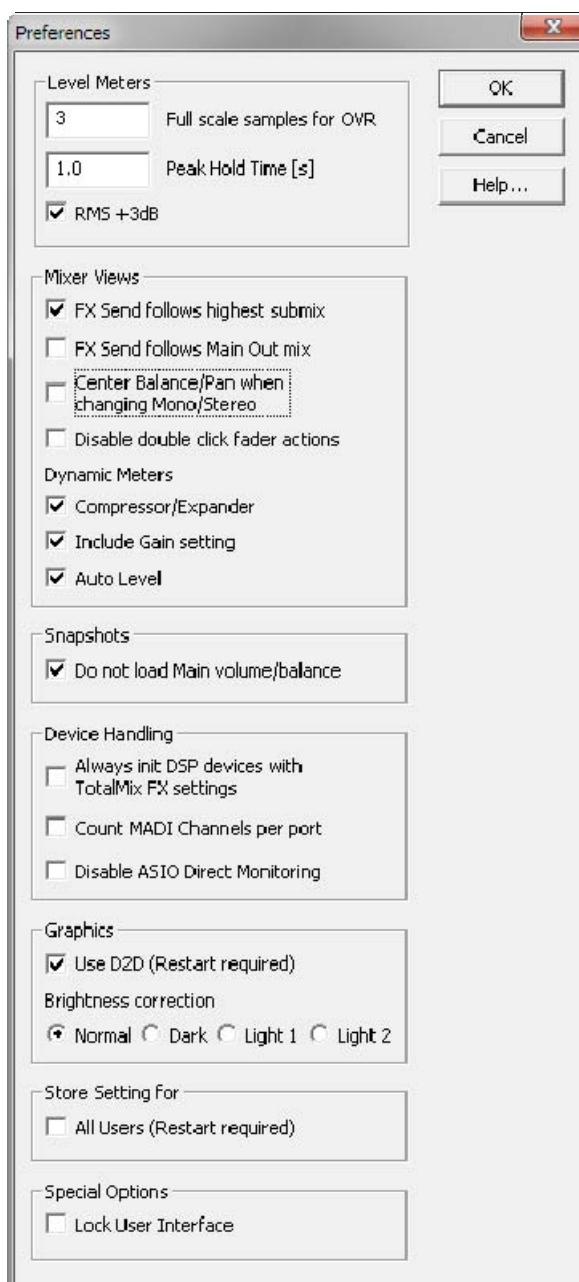

Snapshots

- **Do not load Main volume/balance.** The values stored in the Snapshot are not loaded for the Main Out, so the current setting is not changed.

Device Handling

- **Always init DSP devices with TotalMix FX settings.** Used to suppress the mismatch message after using the unit stand-alone. Settings in the unit are lost.
- **Count MADI Channels per port.** Not available with the Fireface UFX.
- **Disable ASIO Direct Monitoring.** Disables ASIO Direct Monitoring (ADM) for the Fireface UFX within TotalMix FX.

Graphics

- **Use D2D (Change requires restart).** Default on. Can be deactivated to use a compatible but CPU-taxing graphics mode, in case graphics problems show up.
- **Brightness Correction.** Adjusts the brightness of the TotalMix FX graphics.

Store Setting for (Windows only)

- **All Users (Restart required).** See next chapter.

Special Options

- **Lock User Interface.** Default off. Can be activated to freeze the current mix state. Faders, buttons and knobs relating to the mix state can not be moved anymore.

25.7.1 Store for Current or All Users (Windows)

TotalMix FX stores all settings, workspaces and snapshots for the *current user* in:

XP: C:\Documents and Settings\ Username\Local Settings\ Application Data\TotalMixFX

Since Vista: C:\Users\Username\AppData\Local\TotalMixFX

Current User ensures that when workstations are used by several people they all find their own settings. In case the settings should be identical or given for any user, TotalMix FX can be changed to use the *All User* directory. An admin could even write protect the file **lastFirefaceUFX1.xml**, which results in a complete reset to that file's content whenever TotalMix FX is restarted. The xml-file is updated on exit, so simply set up TotalMix as desired and exit it (right mouse click on the symbol in the notification area).

25.8 Settings

The dialog Settings can be opened via the *Options* menu or directly via F3.

25.8.1 Mixer Page

On the mixer page some typical settings for the mixer operation are set, like Talkback source, Dim amount when Talkback is active, the stored main volume or the input used for the External Input function.

Talkback

- **Input.** Selects the input channel of the Talkback signal (microphone in control room). Default: None.
- **Dim.** Amount of attenuation of the signals routed to the *Phones* in dB.

Listenback

- **Input.** Selects the input channel of the Listenback signal (microphone in recording room). Default: None.
- **Dim.** Amount of attenuation of the signals routed to the *Main Out* in dB.

Main Out

- **Recall.** User defined listening volume, activated by the Recall button at the unit or in TotalMix.
- **Dim.** Amount of attenuation for the Main Out in dB.
- **External Input.** Selects the stereo input that replaces the mix signal on the Main Out when activated. The volume of the stereo signal is adjusted by the slider Gain.

PFL Mode

- **Live Mode, PFL replaces Solo.** PFL means Pre Fader Listening. This feature is very useful when operating TotalMix in a live environment, as it allows to quickly listen/monitor any of the inputs by hitting the Solo button. The monitoring happens on the output set for the Cue signal via the Assign dialog.

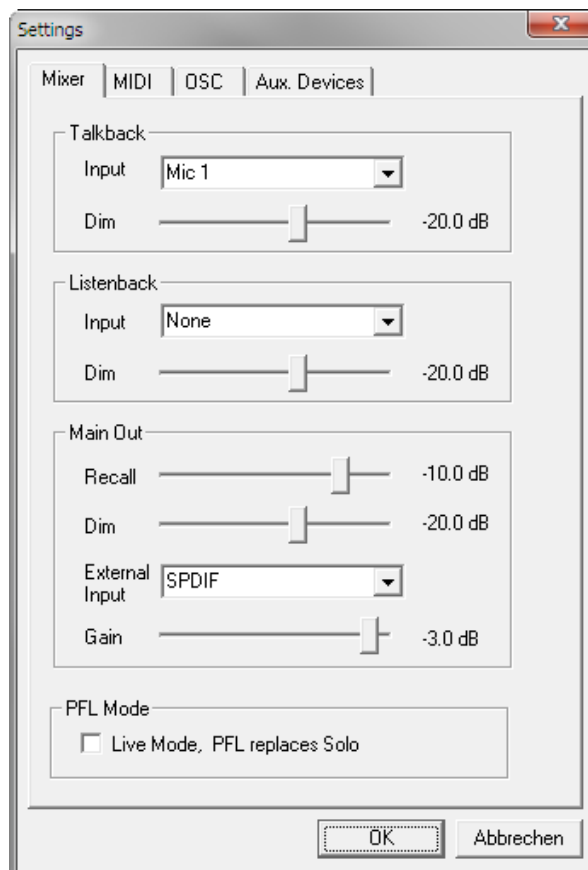

25.8.2 MIDI Page

The MIDI page has four independent settings for up to four MIDI remote controls, using CC commands or the Mackie Control protocol.

Index

Select one of four settings pages and thus remote controls. Settings are remembered automatically. To activate or deactivate any of the four remote controls check or uncheck 'In Use'.

MIDI Remote Control

- **MIDI In.** Input where TotalMix receives MIDI Remote data.
- **MIDI Out.** Output where TotalMix sends MIDI Remote data.
- **Disable MIDI in background.** Deactivates MIDI Remote Control as soon as another application is in the focus, or when TotalMix has been minimized.

Mackie Control Options

- **Enable Protocol Support.** When disabled TM FX will only react on the Control Change commands of chapter 28.5.
- **Extender to.** Sets the current remote to be an extender to the main remote. Both remotes will be shown as one block and navigate simultaneously.
- **Map Stereo to 2 Mono Channels.** One fader controls one (mono) channel. Should be disabled when stereo channels are used.
- **Submix Selection in Input/Playback Row.** Enables a selection of the submix when in first row, without having to change to the third row first. However, when using both mono and stereo channels first and third row usually do not match anymore, so the selection often becomes unclear this way.
- **Enable full LCD support.** Activates full Mackie Control LCD support with eight channel names and eight volume/pan values.
- **Send User defined Names.** Channel names defined by the user will be sent to the remote device via MIDI and – if supported – shown in its display.
- **Send Level Messages.** Activates the transmission of the level meter data. *Peak Hold* activates the peak hold function as set up for the TotalMix level meters in the preferences.

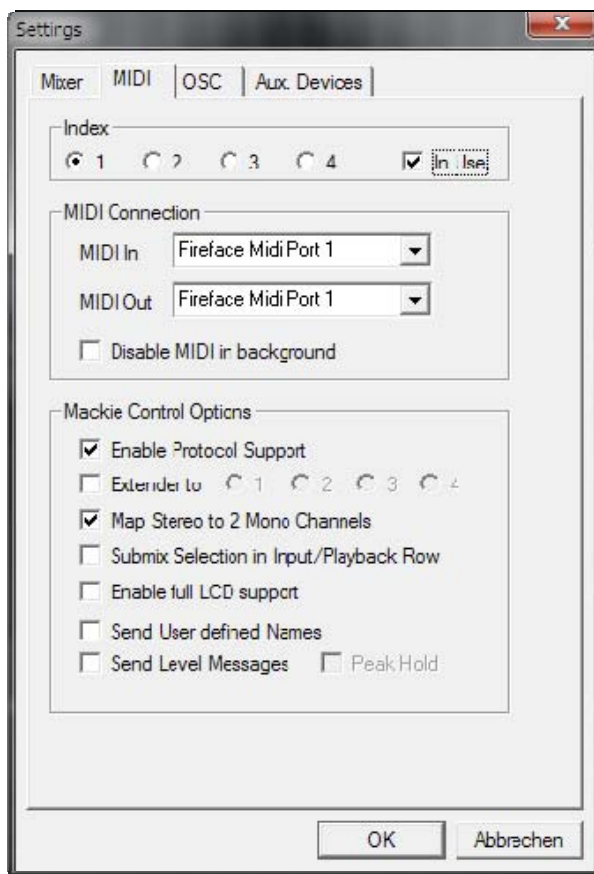

Note: When MIDI Out is set to NONE then TotalMix FX can still be controlled by Mackie Control MIDI commands, but the 8-channel block is not marked as remote target.

25.8.3 OSC Page

The OSC page has four independent settings for up to four MIDI remote controls via Open Sound Control (OSC). This is a network based remote protocol that can be used for example by Apple's iPad with the app *TouchOSC* or *Lemur* to wirelessly remote control TotalMix FX running on a Mac or Windows computer.

Index

Select one of four settings pages and thus remote controls. Settings are remembered automatically. To activate or deactivate any of the four remote controls check or uncheck 'In Use'.

TotalMix FX OSC Service

- **IP.** Shows the network address of the computer running TotalMix FX (local host). This address must be entered on the remote side.
- **Host Name.** Local computer name.
- **Port incoming.** Must match the remote entry 'Port outgoing'. Typical values are 7001 or 8000.
- **Port outgoing.** Must match the remote entry 'Port incoming'. Typical values are 9001 or 9000.

Remote Control

- **IP or Host name.** Enter the IP or host name of the remote control. Please note that the IP number usually works better than the host name.

Options

- **Send Peak Level.** Activates the transmission of the peak level meter data. *Peak Hold* activates the peak hold function as set up for the TotalMix level meters in the preferences.

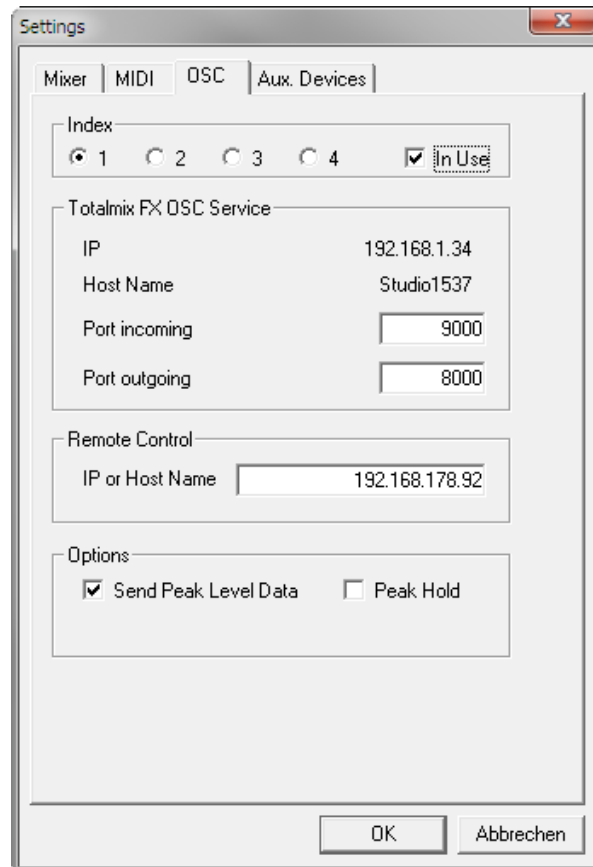

25.8.4 Aux Devices

The RME OctaMic XTC is a highly flexible hi-quality 8-channel microphone, line and instrument preamp with integrated AD-conversion to ADAT, AES/EBU and MADI, plus 4 channels of DA-conversion for monitoring. It can be used as universal front-end for the Fireface UFX and other interfaces.

To simplify operation the most important parameters of the XTC (gain, 48V, phase, mute, AutoSet) can be controlled directly from the TotalMix FX input channels. This special remote control uses MIDI of any format (DIN, USB, MIDI over MADI).

Device Settings

- **Digital Channels.** Select where the OctaMic XTC sends its 8 analog channels to. With the Fireface UFX this will be the ADAT channels 1-8 or 9-16.
- **Device.** At this time only the OctaMic XTC is supported and can be chosen.

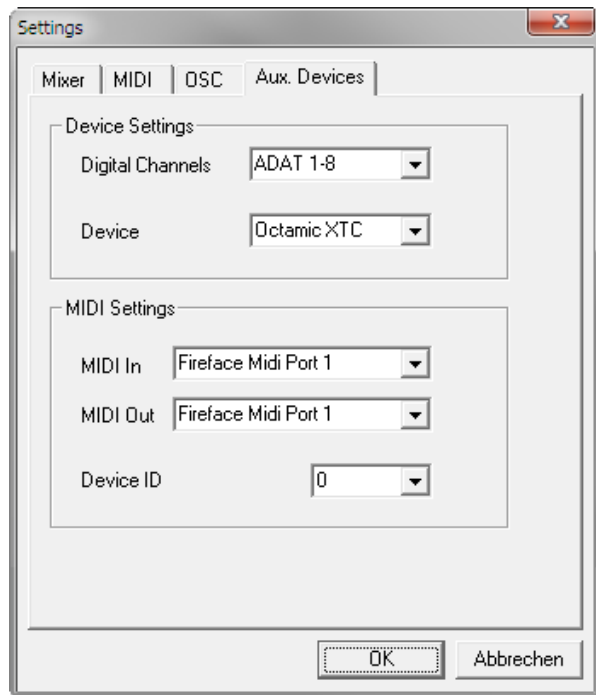

MIDI Settings

- **MIDI In.** Set the currently used MIDI connection to OctaMic XTC.
- **MIDI Out.** Set the currently used MIDI connection to OctaMic XTC.
- **Device ID.** Default 0. This setting relates to the current choice in Digital Channels.

When using more than one OctaMic XTC these must have different Device IDs (configuration is done at the OctaMic XTC). *Aux Devices* supports to set different Device IDs to the 8-channel blocks as well. Storing the setting is done automatically when selecting a Device ID. To check the current assignments toggle the two 8-channel blocks.

The screenshot to the right shows what happens as soon as the above settings have been confirmed with OK. The ADAT channels show new elements for phantom power, Inst/PAD, Gain and AutoSet. Control operates bidirectional, so changing the gain at the unit will be mirrored in the TotalMix channels. Changing the gain in TotalMix FX will set the gain in the unit, which is also shown on the unit's display.

For the remote to work the XTC's currently used MIDI I/Os have to be set to *Control*. More details are found in the manual of the OctaMic XTC.



25.9 Hotkeys and Usage

TotalMix FX has many hotkeys and mouse/hotkey combinations to speed up and simplify the usage. The below description refers to Windows. On Mac substitute *Ctrl* in the below list with the command key (⌘).

The **Shift** key enables a fine-tuning of the gain with all faders and in the Matrix. On all knobs it will speed up the setting.

A click on a **fader** with held down **Shift** key adds the fader to the temporary fader group.

A click in the **fader path** with held down **Ctrl** key will let the fader jump to 0 dB, at the next click to $-\infty$. Same function: Double click of the mouse.

Clicking on one of the **Panorama** or **Gain** knobs with held down **Ctrl** key lets the knob jump to center position. Same function: Double click of the mouse.

Clicking on the **Panorama** knob with held down **Shift** key lets the knob jump to fully left, with **Shift-Ctrl** to fully right.

Clicking on one of the channel settings buttons (slim/normal, Settings, EQ, Dynamics) with held down **Ctrl** key lets all channels to the right change their state. For example all panels can be opened/closed simultaneously.

A **double click** of the mouse on a knob or its numerical field opens the according *Input Value* dialog. The desired value can then be set by keyboard.

Dragging the mouse from a parameter field increases (move up) or decreases (move down) the value in the field.

Ctrl-N opens the dialog *Function Select* to open a new TotalMix window.

Ctrl-W opens the dialog *File Open* of the operating system to load a TotalMix Workspace file.

The key **W** starts the dialog *Workspace Quick Select* for a direct selection or storage of up to 30 Workspaces.

The key **M** switches the active window to Mixer view. The key **X** switches the active window to Matrix view. **Ctrl-M** opens a new Mixer window, **Ctrl-X** opens a new Matrix window. Another Ctrl-M or Ctrl-X closes the new window again.

F1 opens the online help. The Level Meter setup dialog can be opened with **F2** (same as in DIGICheck). The dialog Preferences is opened with **F3**.

Alt-F4 closes the current window.

Alt and **number** keys 1 to 8 (not on the numeric keypad!) will load the corresponding Workspace from the Workspace Quick Select feature (hotkey W).

25.10 Menu Options

Deactivate Screensaver: When active (checked) any activated Windows screensaver will be disabled temporarily.

Always on Top: When active (checked) the TotalMix window will always be on top of the Windows desktop. **Note:** This function may result in problems with windows containing help text, as the TotalMix window will even be on top of those windows, so the help text isn't readable.

Enable MIDI /OSC Control: Activates external MIDI control of the TotalMix mixer. In Mackie Protocol mode the channels which are currently under MIDI control are indicated by a colour change of the name field.

Submix linked to MIDI / OSC control (1-4). The 8-channel group follows the currently selected submix, means Hardware Output, when a different submix is chosen on the remote as well as when doing this in TotalMix. When using multiple windows it can be useful to deactivate this feature for specific windows. The view will not change then.

Preferences: Opens a dialog box to configure several functions of the level meters and the mixer. See chapter 25.7.

Settings. Opens a dialog box to configure several functions like Talkback, Listenback, Main Out and the MIDI Remote Control. See chapter 25.8.

Channel Layout. Hide channels visually and from remote. See chapter 25.5.3.

Key Commands. Opens a dialog box to configure the programmable buttons of the Standard and Advanced Remote, and of the computer's keyboard keys F4 to F8.

Reset Mix. Offers several options to reset the mixer state:

- **Straight playback with all to Main Out.** All Playback channels are routed 1:1 to the Hardware Outputs. Simultaneously all playbacks are mixed down to the Main Out. The faders in the third row are not changed.
- **Straight Playback.** All Playback channels are routed 1:1 to the Hardware outputs. The faders in the third row are not changed.
- **Clear all submixes.** Deletes all submixes.
- **Clear channel effects.** Switches off all EQs, Low Cuts, Reverb, Echo, Dynamics and Stereo Width and sets their knobs to default position.
- **Set output volumes.** All faders of the third row set to 0 dB, Main and Speaker B to -10 dB.
- **Reset channel names.** Removes all names assigned by the user.
- **Set all channels mono.** Reconfigures all TotalMix FX channels to mono mode.
- **Set all channels stereo.** Reconfigures all TotalMix FX channels to stereo mode.
- **Set inputs mono / outputs stereo (ADM).** Preferred setup for best ASIO Direct Monitoring compatibility. In most cases mono hardware outputs will break ADM. Mono inputs are in most cases compatible. If not wrong panning might occur.
- **Total Reset.** Playback routing 1:1 with mixdown to Main Out. Switches off all other functions.

Store Current state into device. The unit can store up to 6 setups (the current state) in its own memory. This function is especially useful when working in stand-alone mode.

25.11 Menu Window

Zoom Options 100%, 135%, 200%. Depending on the size of the monitor and the current resolution TotalMix FX might be much too small and the controls too tiny to easily operate them. Together with the 2 Row mode these options give a lot of different window sizes that suit all monitors and resolutions currently existing.

Hide Control Strip. Shifts the Control Strip out of the visible area to gain more space for other elements.

26. The Matrix

26.1 Overview

The mixer window of TotalMix looks and operates similar to mixing desks, as it is based on a conventional stereo design. The matrix display presents a different method of assigning and routing channels, based on a single channel or monaural design. The matrix view of the Fireface UFX has the look and works like a conventional patchbay, adding functionality way beyond comparable hardware and software solutions. While most patchbays will allow you to connect inputs to outputs with just the original level (1:1, or 0 dB, as known from mechanical patchbays), TotalMix allows you to use a freely definable gain value per crosspoint.

Matrix and TotalMix are different ways of displaying the same processes. Because of this both views are always fully synchronized. Each change in one view is immediately reflected in the other view as well.

26.2 Elements of the Matrix View

The visual design of the TotalMix Matrix is mainly determined by the architecture of the Fireface UFX system:

- **Horizontal labels.** All hardware outputs
- **Vertical labels.** All hardware inputs. Below are all playback channels.
- **Green 0.0 dB field.** Standard 1:1 routing
- **Dark grey field with number.** Shows the current gain value as dB
- **Blue field.** This routing is muted
- **Red field.** Phase 180° (inverted)
- **Dark grey field.** No routing.

	Out 1	Out 2	Out 3	Out 4	Out 5
Mic 1/2	-0.0	-5.5			
AN 3			0.0		
AN 4				-18.3	
AN 5/6					
AN 7/8					

To maintain overview when the window size has been reduced, the labels are floating. They won't leave the visible area when scrolling.

26.3 Operation

Using the Matrix is a breeze. It is very easy to identify the current crosspoint, because the outer labels light up in orange according to the mouse position.

- If input 1 is to be routed to output 1, use the mouse and click one time on crosspoint **In 1 / AN 1** with held down Ctrl key. Two green 0.0 dB field pop in, another click removes them.
- To change the gain (equals the use of a different fader position, see simultaneous display of the mixer view), drag the mouse up or down, starting from the gain field. The value within the field changes accordingly. The corresponding fader in the mixer view is moving simultaneously, in case the currently modified routing is visible.
- On the right side is the Control Strip from the mixer window, adapted to the Matrix. The button for the temporary fader group is missing as well as all View options, as they don't make sense here. Instead the button *Mono Mode* lets you decide whether all the actions performed in the Matrix are valid for two channels or just one.

The Matrix not always replaces the mixer view, but it significantly enhances the routing capabilities and - more important - is a brilliant way to get a fast overview of all active routings. It shows you in a glance what's going on. And since the Matrix operates monaural, it is very easy to set up specific routings with specific gains.

27. Tips and Tricks

27.1 ASIO Direct Monitoring (Windows)

Programs that support ADM (ASIO Direct Monitoring - Samplitude, Sequoia, Cubase, Nuendo etc.) send control commands to TotalMix. This is directly shown by TotalMix. When a fader is moved in the ASIO host the corresponding fader in TotalMix will move too. TotalMix reflects all ADM gain and pan changes in real-time.

But: the faders only move when the currently activated routing (the selected submix) corresponds to the routing in the ASIO host. The Matrix on the other hand will show any change, as it shows all possible routings in one view.

27.2 Copy a Submix

TotalMix allows you to copy complete submixes to other outputs. In case a complex submix is needed with only a few changes on a different output, the whole submix can be copied to that output. Right click with the mouse on the original submix output, means Hardware Output. In the context menu select Copy Submix. Then right click on the new submix output, choose Paste Submix in the context menu. Now fine tune the submix.

27.3 Doubling the Output Signal (Mirror)

If a mix should be sent out via two (or more) different hardware outputs simply mirror that mix to any number of other outputs. A right click on the original output brings up the option to *Copy/Mirror <name>*. Another right click on the new output, then selecting *Mirror of Output <name>* will paste the whole submix and then synchronize it automatically to any future changes. The outputs now always send out the same signals, but their main volume (fader) and the EQ and Dynamics settings stay fully independent.

27.4 Delete a Submix

The easiest and quickest way to delete complex routings is by selection of the according output channel in the mixer view by a right mouse click, and selection of the menu entry *Clear Submix*. As TotalMix FX includes an unlimited undo the delete process can be undone without any problem.

27.5 Copy and Paste everywhere

The above three tips use functions found in the right click context menu available on all channels of the mixer view. These menus are also available in the Matrix, but only directly on the channel labels. They are self-explanatory and automatically adjust to where the click is performed. The input channels offer *Clear*, *Copy input*, *Paste the input mix* and *Paste its FX*. On a playback channel *Copy*, *Paste* and *Clear the playback mix* are available. On an output channel *Copy* and *Mirror* functionality for the current submix and *copying* of the FX settings is offered.

These options are very advanced and mighty tools to quickly do the impossible. Still there is no need to fear breaking something, as a simple click (or several) on the Undo button will get you back to where you started!

27.6 Recording a Submix - Loopback

TotalMix includes an internal loopback function, from the Hardware Outputs to the recording software. Instead of the signal at the hardware input, the signal at the hardware output is sent to the record software. This way, submixes can be recorded without an external loopback cable. Also the playback from a software can be recorded by another software.

The function is activated by the **Loopback** button in the Settings panel of the Hardware Outputs. In loopback mode, the signal at the hardware input of the corresponding channel is no longer sent to the recording software, but still passed through to TotalMix. Therefore TotalMix can be used to route this input signal to any hardware output. Using the subgroup recording, the input can still be recorded on a different channel.

As each of the 15 stereo hardware outputs can be routed to the record software, and none of these hardware inputs get lost, TotalMix offers an overall flexibility and performance not rivalled by any other solution.

The risk of feedbacks, a basic problem of loopback methods, is low, because the feedback can not happen within the mixer, only when the audio software is switched into monitoring mode.

The block diagram shows how the software's input signal is played back, and fed back from the Hardware Output to the software input.

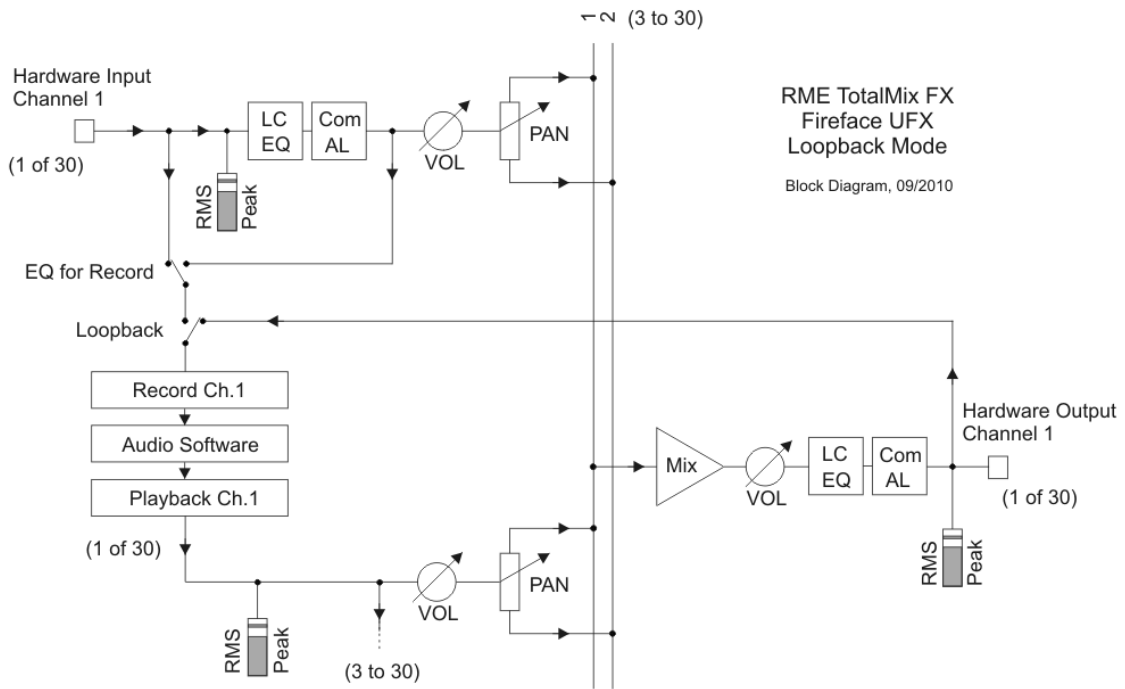

The block diagram also shows why with activated Loopback the EQ of the Hardware Output is now within the record path. With Loopback active the EQ of the input is not in the record path, only in the monitoring path, even when the Option *DSP – EQ+D for Record* is activated.

Recording a Software's playback

In real world application, recording a software's output with another software will show the following problem: The record software tries to open the same playback channel as the playback software (already active), or the playback one has already opened the input channel which should be used by the record software.

This problem can easily be solved. First make sure that all rules for proper multi-client operation are met (not using the same record/playback channels in both programs). Then route the playback signal via TotalMix to a hardware output in the range of the record software, and activate Loopback for recording.

Mixing several input signals into one record channel

In some cases it is useful to record several sources into only one track. For example when using two microphones recording instruments and loudspeakers, TotalMix' Loopback mode saves an external mixing desk. Simply route/mix the input signals to the same output (third row), then redefine this output into a record channel via Loopback. This way any number of input channels from different sources can be recorded into one single track.

27.7 MS Processing

The mid/side principle is a special positioning technique for microphones, which results in a mid signal on one channel and a side signal on the other channel. This information can be transformed back into a stereo signal quite easily. The process sends the monaural mid channel to left and right, the side channel too, but phase inverted (180°) to the right channel. For a better understanding: the mid channel represents the function L+R, while the side channel represents L-R.



	Out 1	Out 2	Out 3
Mic 1/2	-6.0	-11.5	
AN 3	-6.0	-11.5	
AN 4			

During record the monitoring needs to be done in 'conventional' stereo. Therefore TotalMix also offers the functionality of a M/S-decoder. Activation is done in the Settings panel of the Hardware Input and Software Playback channels via the **MS Proc** button.

The M/S-Processing automatically operates as M/S encoder or decoder, depending on the source signal format. When processing a usual stereo signal, all monaural information will be shifted into the left channel, all stereo information into the right channel. Thus the stereo signal is M/S encoded. This yields some interesting insights into the mono/stereo contents of modern music productions. Additionally some very interesting methods of manipulating the stereo base and generating stereo effects come up, as it is then very easy to process the side channel with Low Cut, Expander, Compressor or Delay.

The most basic application is the manipulation of the stereo width: a change of the level of the side channel allows to manipulate the stereo width from mono to stereo up to extended.

28. MIDI Remote Control

28.1 Overview

TotalMix can be remote controlled via MIDI. It is compatible to the widely spread Mackie Control protocol, so TotalMix can be controlled with all hardware controllers supporting this standard. Examples are the Mackie Control, Tascam US-2400 or Behringer BCF 2000.

Additionally, the stereo output faders (lowest row) which are set up as *Main Out* in the Control Room section can also be controlled by the standard **Control Change Volume** via **MIDI channel 1**. With this, the main volume of the Fireface is controllable from nearly any MIDI equipped hardware device.

MIDI Remote Control always operates in View *Submix* mode, even when the View Option *Free* is currently selected in TotalMix FX.

28.2 Mapping

TotalMix supports the following Mackie Control surface elements*:

Element:	Meaning in TotalMix:
Channel faders 1 – 8	volume
Master fader	Main Out channel fader
SEL(1-8) + DYNAMICS	Activate Trim mode
V-Pots 1 – 8	pan
pressing V-Pot knobs	pan = center
CHANNEL LEFT or REWIND	move one channel left
CHANNEL RIGHT or FAST FORWARD	move one channel right
BANK LEFT or ARROW LEFT	move eight channels left
BANK RIGHT or ARROW RIGHT	move eight channels right
ARROW UP or Assignable1/PAGE+	move one row up
ARROW DOWN or Assignable2/PAGE-	move one row down
EQ	Master Mute
PLUGINS/INSERT	Master Solo
STOP	Dim Main Out
PLAY	Talkback
PAN	Mono Main Out
FLIP	Speaker B
DYN	TrimGains
MUTE Ch. 1 – 8	Mute
SOLO Ch. 1 – 8	Solo
SELECT Ch. 1 – 8	Select
REC Ch. 1 – 8	select output bus (Submix)
RECORD	Recall
F1 - F8	load Snapshot 1 - 8
F9	select Main Out
F10 - F12	select Cue Phones 1 - 3

*Tested with Behringer BCF2000 Firmware v1.07 in Mackie Control emulation for Steinberg mode and with Mackie Control under Mac OS X.

28.3 Setup

Open the Preferences dialog (menu Options or F3). Select the MIDI Input and MIDI Output port where your controller is connected to.

When no feedback is needed select NONE as MIDI Output.

Check *Enable MIDI Control* in the Options menu.

28.4 Operation

The channels being under Mackie MIDI control are indicated by a colour change of the name field, black turns to brown.

The 8-fader block can be moved horizontally and vertically, in steps of one or eight channels.

Faders can be selected to gang them.

In Submix View mode, the current routing destination (output bus) can be selected via REC Ch. 1 – 8. This equals the selection of a different output channel in the lowest row by a mouse click when in Submix View. In MIDI operation it is not necessary to jump to the lowest row to perform this selection. This way even the routing can be easily changed via MIDI.

Full LC Display Support. This option in Preferences (F3) activates complete Mackie Control LCD support with eight channel names and eight volume/pan values. When *Full LC Display Support* is turned off, only a brief information about the first fader of the block (channel and row) is sent. This brief information is also available on the LED display of the Behringer BCF2000.

Disable MIDI in Background (menu Options, Settings) disables the MIDI control as soon as another application is in the focus, or in case TotalMix has been minimized. This way the hardware controller will control the main DAW application only, except when TotalMix is in the foreground. Often the DAW application can be set to become inactive in background too, so that MIDI control is switched between TotalMix and the application automatically when switching between both applications.

TotalMix also supports the 9th fader of the Mackie Control. This fader (labelled Master) will control the stereo output faders (lowest row) which are set up as *Main Out* in the Control Room section.

28.5 MIDI Control

The hardware output which is set up as *Main Out* can be controlled by the standard **Control Change Volume** via **MIDI channel 1**. With this, the main volume of the Fireface is controllable from nearly any MIDI equipped hardware device.

Even if you don't want to control all faders and pans, some buttons are highly desired to be available in 'hardware'. These are mainly the *Talkback* and the *Dim* button, and the monitoring options (listen to Phones submixes). Fortunately a Mackie Control compatible controller is not required to control these buttons, as they are steered by simple Note On/Off commands on MIDI channel 1.

The notes are (hex / decimal / keys):

Dim: 5D / 93 / **A 6**

Mono: 2A / 42 / **#F 2**

Talkback: 5E / 94 / **#A 6**

Recall: 5F / 95 / **H 6**

Speaker B: 32 / 50 / **D3**

Cue Main Out: 3E / 62 / **D 4**

Cue Phones 1: 3F / 63 / **#D 4**

Cue Phones 2: 40 / 64 / **E 4**

Cue Phones 3: 41 / 65 / **F 4**

Cue Phones 4: 42 / 66 / **#F 4**

Snapshot 1: 36 / 54 / **#F 3**

Snapshot 2: 37 / 55 / **G 3**

Snapshot 3: 38 / 56 / **#G 3**

Snapshot 4: 39 / 57 / **A 3**

Snapshot 5: 3A / 58 / **#A 3**

Snapshot 6: 3B / 59 / **B 3**

Snapshot 7: 3C / 60 / **C 4**

Snapshot 8: 3D / 61 / **#C 4**

Trim Gains: 2D / 45 / **A 2**

Master Mute: 2C / 44 / **#G 2**

Master Solo: 2B / 43 / **G 2**

Furthermore all faders of all three rows can be controlled via simple **Control Change** commands. The format for the Control Change commands is:

Bx yy zz

x = MIDI channel

yy = control number

zz = value

The first row in TotalMix is addressed by MIDI channels 1 up to 4, the middle row by channels 5 up to 8 and the bottom row by channels 9 up to 12.

16 Controller numbers are used: 102 up to 117 (= hex 66 to 75). With these 16 Controllers (= faders) and 4 MIDI channels each per row, up to 64 faders can be controlled per row (as required by the HDSPe MADI).

Examples for sending MIDI strings:

- Set input 1 to 0 dB: B0 66 68
- Set input 17 to maximum attenuation: B1 66 0
- Set playback 1 to maximum: B4 66 7F
- Set Output 16 to 0 dB: B8 75 68

Note: Sending MIDI strings requires to use programmer's logic for the MIDI channel, starting with 0 for channel 1 and ending with 15 for channel 16.

Further functions:

- Trim Gains On: BC 66 xx (BC = MIDI channel 13, xx = any value)
- Trim Gains Off: BC 66 xx or select a submix

Select submix (fader) in third row:

- channel 1/2: BC 68/69 xx
 - channel 3/4: BC 6A/6B xx
- etc.

Input Gain control is available via CC9, value range as the gain itself (up to 65). The MIDI channel determines the controlled channel, from 1 to 16 (UFX: 9 to 12). For this to work, *Enable MIDI Control* in the Options menu has to be activated.

The **Reverb** and **Echo User Presets** can be changed via MIDI CC: B2 0C nn for Reverb preset 1 to 16, B3 0C nn for Echo preset 1 to 16

28.6 Stand-Alone MIDI Control

When not connected to a computer, the Fireface UFX can be controlled directly via MIDI. The **stand-alone MIDI control mode** is activated in the unit's menu *Options, HW Options/Diagnosis, Standalone MIDI*.

Note: When not needed the stand-alone MIDI operation should not be active, as the unit will react on MIDI notes after power-on, and will also send MIDI notes.

Control is performed via both the **Mackie Control protocol** and some **standard** MIDI functions (see below). In stand-alone mode not all functions known from TotalMix are available, because some of them aren't hardware, but software routines. Functions like *Talkback, Mono, Solo, relative* ganging of the faders, *Monitor Main* and *Monitor Phones* are realized by complex software code, therefore not available in stand-alone MIDI control operation.

Still many functions, and especially the most important functions to control the Fireface UFX, are implemented in hardware, thus available also in stand-alone mode:

- All faders and pans of the first and third row
- Mute of the input signal per channel
- Ganging via 'Select'
- Choice of the routing destination, i.e. the current submix
- Sending of LED and display data to the MIDI controller

The second row (software playback) is skipped. The Fireface UFX sends display data as brief information, enabling an easy navigation through lines and rows. Other data like PAN and miscellaneous status LEDs are supported as well.

In stand-alone mode the unit always operates in **View Submix** mode. Only this way the routing destination can be changed, and several mixdowns/submixes can be set up quickly and easily. If the current TotalMix setup is transferred into the Fireface via 'Flash current mixer state', the currently selected submix output is also pre-configured in the hardware for stand-alone MIDI remote operation.

Mackie Control Protocol

The stand-alone operation supports the following Mackie Control surface elements*:

*Tested with Behringer BCF2000 Firmware v1.07 in Mackie Control emulation for Steinberg mode.

Element:	Meaning in Fireface:
Channel faders 1 – 8	volume
V-Pots 1 – 8	pan
pressing V-Pot knobs	pan = center
CHANNEL LEFT or REWIND	move one channel left
CHANNEL RIGHT or FAST FORWARD	move one channel right
BANK LEFT or ARROW LEFT	move eight channels left
BANK RIGHT or ARROW RIGHT	move eight channels right
ARROW UP or Assignable1/PAGE+	move one row up
ARROW DOWN or Assignable2/PAGE-	move one row down
STOP	Dim Main Out
EQ	Master Mute
MUTE Ch. 1 – 8	Mute
SELECT Ch. 1 – 8	Select
REC Ch. 1 – 8	select output bus (current submix)
F1 – F6	load Setup 1 - 6

Additionally the following functions are available via simple MIDI notes on MIDI channel 1:

Dim: 5D / 93 / **A 6**

Setup 1: 36 / 54 / **#F 3**

Setup 2: 37 / 55 / **G 3**

Setup 3: 38 / 56 / **#G 3**

Setup 4: 39 / 57 / **A 3**

Setup 5: 3A / 58 / **#A 3**

Setup 6: 3B / 59 / **B 3**

Loading the Setups stored in the device enables a quick configuration change of the UFX. With this any possible operation state can be activated by the push of a button at any time.

28.7 Loopback Detection

The Mackie Control protocol requires feedback of the received commands, back to the hardware controller. So usually TotalMix will be set up with both a MIDI input and MIDI output. Unfortunately any small error in wiring and setup will cause a MIDI feedback loop here, which then completely blocks the computer (the CPU).

To prevent the computer from freezing, TotalMix sends a special MIDI note every 0.5 seconds to its MIDI output. As soon as it detects this special note at the input, the MIDI functionality is disabled. After fixing the loopback, check *Enable MIDI Control* under Options to reactivate the TotalMix MIDI.

28.8 OSC (Open Sound Control)

Besides simple MIDI notes, the Mackie Protocol and Control Change commands, TotalMix FX can also be controlled by the Open Sound Control, OSC. For details on setup and usage see chapter 25.8.3.

An OSC implementation chart can be downloaded from the RME website:

http://www.rme-audio.de/download/osc_table_totalmix.zip

RME offers a free iPad template for the iOS app TouchOSC (by Hexler, available in the Apple App-Store):

http://www.rme-audio.de/download/tosc_tm_ipad_template.zip

The RME forum hosts further information, more templates (iPhone...) and lots of useful user feedback.

User's Guide



Fireface UFX

▶ Class Compliant Mode

29. General

Since firmware 353/153/CC8 the Fireface UFX operates in three different modes: **driver-based USB 2**, **stand-alone** mode, and **Class Compliant** mode. The latter describes a standard that is natively supported by operating systems like Windows, Mac OS X and Linux. No proprietary drivers are required, the device will be directly recognized when the CC firmware is loaded. The natively available features will be limited in comparison to those provided by the RME driver for the UFX. For example there will be no hardware settings, no (Total) Mix and no settings for the effects. On the iPad (iOS) the UFX can be fully controlled by the optional app *TotalMix FX for iPad*.

The Class Compliant mode can be activated and deactivated directly at the unit, as long as it is not connected to a Mac or PC: SETUP/REV, Options, Hardware/Diagnosis.

Neither Windows nor Mac Class Compliant support is relevant, though, since there are dedicated and matured drivers for both OS X and Windows, which provide ALL the device's features at lowest latencies. The main reason for implementing Class Compliant mode was to allow connecting the UFX to an **Apple iPad®**!

The UFX provides the iPad with the professional analog I/O connections it lacks. Superb microphone preamps with EQ, dynamics, even with the AutoSet feature, in addition to professional balanced line outputs, and hi-power headphone outputs which also excel with high impedance phones. Plus level and gain adjustments, AES and ADAT I/O, reverb, echo, zero latency monitoring, digitally via USB, without any limitation in quality, at up to 96 kHz and 24 bit. And of course a Sysex-capable double MIDI I/O.

DURec, the direct USB recording on USB memory stick or portable external hard drive, is also available in Class Compliant mode. Especially in regard to recording on the iPad it is not only a world-wide unique and extraordinary feature, it also proves to be something you don't want to miss in real-world usage.

Note that since iOS 5 multichannel recording is supported, and since iOS 6 multichannel playback as well. Currently **djay**, **Auria** and **Cubasis** support more than one stereo output, others are expected to follow.

30. System requirements

- UFX in Class Compliant mode (firmware CC 21 or up)
- Any Apple iPad with at least iOS 5
- iPhone with iOS 7 or up
- Apple iPad Camera Connection Kit or Lightning to USB adapter

31. Operation

Activation of the Class Compliant mode: Remove USB and FireWire cable from the UFX. Press SETUP/REV. Turn encoder 1 until Options appears in the display. Turn encoder 2 until Hardware/Diagnosis appears. Push encoder 2 several times to select the entry *CC Mode*. Turn encoder 2 to switch CC mode on (or off). The UFX reboots, all LEDs light up, after which it will be in Class Compliant mode.

The option *CC Routing* offers two different routings of the playback signals. See chapter 34.

Connect the USB cable to the UFX and the Camera Connection Kit. Start the iPhone/iPad and connect the Camera Connection Kit. If everything works as expected, the unit will enter CC host mode, indicated by the blue USB LED turning on. Audio playback in iTunes will automatically be performed by the UFX, using analog outputs 1/2 and the phones outputs 9/10, 11/12, AES and ADAT (routing *Phones*).

Apps that support MIDI and are ready for Core MIDI (available since iOS 4.2) will offer dialogs to select the desired UFX MIDI inputs and outputs.

31.1 Useful hints

If the unit is not in CC mode, the iPhone/iPad will detect an incompatible USB device, and display a message saying “Cannot Use Device – The connected USB device is not supported”.



When using hard covers as back panel protection for the iPad, the Connection Kit's plug may not fit completely, causing a loose connection or partial functionality. If in doubt, remove the cover.

No sound: Incorrect output gain settings, see chapter 34.

The iPhone/iPad volume control is inactive during USB operation.

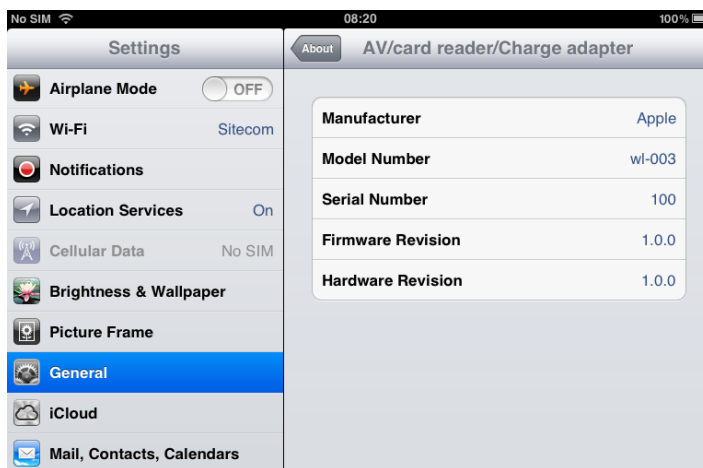

If the unit does not enter Host mode: Remove and reconnect the Connection Kit.

Correct detection and operation of the Connection Kit itself can be determined in Settings / General / About. The adapter will be listed there right after connection, with additional details like manufacturer, model number etc. Connected USB devices, i.e. the UFX will not be shown here, though.



Having tested several chinese replicas of the Apple Camera Connection Kit, from 2-in-1 to 5-in-1 adapters, we strongly recommend purchasing the original!

All adapters seemed to work for the simple application of copying photos. Attempting to run the UFX with USB Audio 2.0 was when the problems started. Some of the tested adapters would not work at all, others only with short cables, and only one adapter came close to the quality of the original. But as soon as 8-channel recording or 96 kHz playback was initiated, the Apple Kit always performed much better.



We also recommend the purchase of a dock-to-dock extension cable, to avoid having the CCK attached to the iPad directly with the heavy USB cable hanging down.

This can cause the CCK to slip out of the iPad's connector, or to be in the way most of the time. An extension cable provides enormous freedom of movement. We are working with cable lengths of 50 cm and 1 m, both work flawlessly. These cables are available as *DeLock iPhone extension cable*, or *Dock Extender*, e.g. from Amazon.

It is important to note that each individual component is responsible for stable operation of UFX and iPhone/iPad. As an example, a setup with an iPad connected to a 1 m DeLock cable, CCK, 5 m USB connection to the UFX only worked with the original Apple CCK. Not only for simple iTunes stereo playback, but also with 96 kHz playback and 8-channel recording. In this setup, the USB cable could even be replaced with a 10 m active one. With lower quality cables or CCK replicas, even 50 cm dock to dock to 1 m USB would be considered success...

As far as we are aware active cable extensions for Lightning are not available. The existing passive extensions make no sense due to the doubled thickness of their cable (double the amount of wires inside), and the used Lightning connectors are no originals and therefore usually lack quality. The original adapter with its short cable is lightweight and works, can therefore be used easily with iPad and iPhone.

31.2 Class Compliant Mode under Windows and Mac OS X

On a Windows PC, Class Compliant mode is indicated by a missing “RME” in the device name shown in the Device Manager. In the correct mode and with installed drivers, the full name including RME is shown, without serial number.

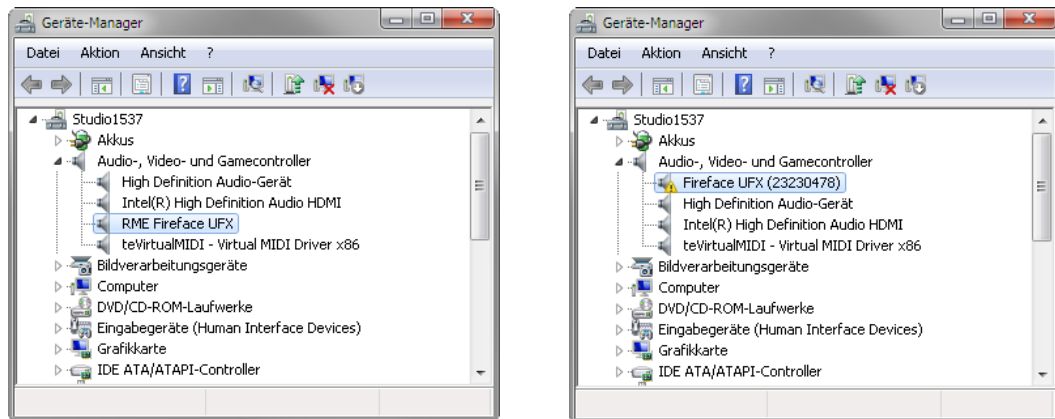

Windows does not support USB Audio 2.0 directly. The UFX will be detected, but automatic driver installation will fail. This is important to remember. Connecting it to the PC one day after having it used with the iPhone/iPad one might forget that it is still in CC mode. You might end up with hours of wasted time trying to repair your driver installation – when all you need to do is set the unit back to normal mode.

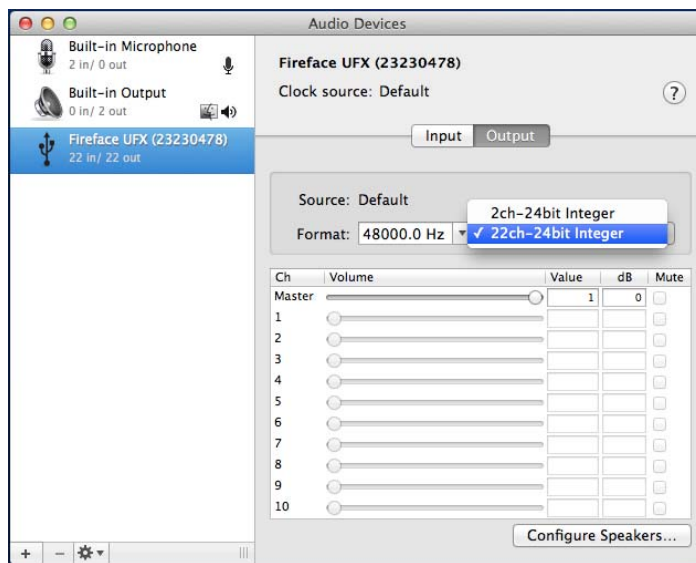

Mac OSX supports USB Audio 2.0, even with more than 2 channels. The UFX offers 22 input and 22 output channels at up to 96 kHz. It is shown as “Fireface UFX (xxxxxxx)” in the Audio MIDI Setup, in both normal and CC mode. In CC mode the USB Settings will vanish from the Dock, and TotalMix will – if at all – show a ‘disconnected’ UFX.

The Audio window in the Audio MIDI Setup lists two available modes: 2 channels and 22 channels. The sample rate shown here as ‘Default’ is the one set at the UFX.

32. Supported Inputs and Outputs

In Mac OS X, either the first two or 22* channels will work, depending on the choice in the Audio MIDI Setup. In both cases the playback signal of channels 1/2 can be copied to other outputs.

When connected to an iPad, the analog mic/line input 1 works with mono apps, inputs 1 and 2 with stereo apps (both dual mono and stereo), and up to 8 inputs with 8-channel applications like *MultiTrack DAW* and *Music Studio*. *Garage Band* supports all inputs, but only two at a time. *Auria* and *Cubasis* can record all 22 inputs simultaneously.

Playback will use the rear-side analog outputs 1 and 2, or even more channels if the app supports such operation. The UFX can optionally copy the iPhone/iPad playback channels 1/2 to outputs 9/10, 11/12, AES and ADAT, for easier monitoring (routing *Phones*). All outputs can be processed independently (volume, EQ, dynamics, FX return).

Configuring the UFX is ideally done via the app *TotalMix FX for iPad*, otherwise by loading Setups. These are written into the unit while operated with PC/Mac via *TotalMix FX*, and also control clock mode master or *AutoSync* and the sample rate. The UFX (and with it the iPhone/iPad) will be synchronized to an external digital sample rate if there is a valid digital input signal. With a wrong sample rate heavy audio noise will occur. Without an SPDIF or ADAT input signal the UFX enters master mode and uses the sample rate set by Mac OS X or iOS (the app in use).

While the MIDI I/Os will send and receive Sysex messages, not all apps are ready to do this. For example *MIDI Monitor* and *AC-7* do not support Sysex at this time. The app *Midi Tool Box* can be used to verify that the UFX is working correctly, and the problem lies somewhere else.

* Analog 1 to 12, AES, ADAT 1 to 8. At 88.2/96 kHz ADAT AUX In will become active. ADAT AUX Out mirrors the outputs Analog 1 to 8 in Single Speed, or operates as optical SPDIF output for Analog 1/2. The current routing can easily be checked and verified with the level meter display.

33. Front panel operation

The front panel operation is identical to the one under Windows and OS X, or standalone operation. The display therefore gives the usual easy access to all features and offers a quick editing of: input gains, playback levels, routing and monitoring, echo, reverb, EQ, dynamics, sample rate, status of the optical output (ADAT/SPDIF), and much more.

34. Audio Routing and Processing

In Class Compliant mode, the UFX features operation very similar to normal operation with *TotalMix FX*, with two major differences:

- There is no second *TotalMix* row (no software playback channels), hence no individual routing or mixing of playback channels. These will always be connected either straight to the physical outputs (22 Ch.), or have an additional signal copy from 1/2 to 9/10, 11/12 and SPDIF/ADAT (*Phones*), making the headphone output usable even in stereo mode.
- The input effects EQ/Dyn will always be active in the recording path

The UFX can be pre-configured for CC mode via *TotalMix FX* under Windows/Mac by saving up to 6 configurations into its setup memory.

The input signal will pass through all activated functions of the TM FX input channel, namely settings, EQ, and Dynamics, and is then sent to the iPhone/iPad. Like under Windows and Mac, the input fader setting controls direct monitoring to the specified outputs. The FX send control for echo/reverb is also active.



As in normal TotalMix FX use, the options Stereo Width, MS Proc and Phase L/R are NOT within the recording path, but in the monitor path. This is technically determined and can not be changed.

The iPhone/iPad output signal passes through all activated functions of the TM FX hardware outputs, namely settings, EQ, and dynamics. The third row's fader sets the output level.



Control Room Section settings are inactive. Configuring the Phones output is done by output channel 9/10 and 11/12.

With the mirroring of signals to AES and ADAT outputs in Phones mode, the UFX features two simultaneously usable digital outputs, with independent processing (volume, EQ, Dyn, FX Return), even when using standard 2-channel apps.

Details on the routing presets for playback of apps running on the iPhone/iPad:

Phones: The iPhone/iPad playback channels 1/2 are copied to the phones outputs 9/10, 11/12, AES and ADAT MAIN, channels 3 to 8 to ADAT outputs 3 to 8. ADAT AUX Out mirrors the outputs Analog 1 to 8 in Single Speed, or operates as optical SPDIF output for Analog 1/2. Application example iTunes: Music playback with this 2-channel app happens only on the playback channels 1/2, therefore the headphones could not be used. Thanks to the *Phones* routing the iTunes signal is also available digitally via AES/ADAT.

22 Ch.: 1:1 routing of all 22 playback channels. Application example djay: independent usage of main output and phones/PFL. The routing *Phones* would provide only the main signal at the phones output. 22 Ch. is a typical DAW mode.

Both modes can be activated at any time and do not influence the mixer state loaded via the Setups, as they only influence the playback routing. The current routing can easily be checked and verified with the level meter display.

35. Setups

TotalMix FX can transfer all current settings to the device (Options/Store Current State into Device). There are six memory slots (Setups) available. An example:

- Inputs with no processing, gain set to +30 dB and phantom power active. Outputs without processing, faders for 1/2 set to 0 dB, 9/10 at – 20 dB, clock mode master, saved in Setup 1.
- Inputs with Compressor, Factory Preset Mix Limiter (digital overload protection), gain set to +30 dB, no phantom power, outputs 1/2 with EQ (factory preset Modern Bass Treble), outputs 9/10 with EQ (factory preset Cheap Phones Compensation), faders for 1/2 at 0 dB, 9/10 at -20dB, clock mode AutoSync, saved in Setup 2.

Via the menu SETUP/REV, Setup, one can switch between setups 1 and 2 at any time, alternating between entirely different configurations. Further examples would be activating reverb/echo, or temporary monitoring of the input signal. Very comfortable is the use of the Advanced Remote, as in CC mode its 6 upper buttons steer the Setups 1 to 6 directly

On the iPad the optional app *TotalMix FX for iPad* gives full control of all functions and parameters in real-time and with full overview, similar to working under Windows and Mac.

User's Guide



Fireface UFX

▶ **DURec™ - Direct USB Recording**

36. Direct USB Recording

36.1 Overview

The Fireface UFX can record and playback up to 60 channels of audio via the USB port on the front panel. This functionality is provided by the internal DSP and is therefore independent from a Windows or Mac computer connected via USB or FireWire.

As all settings are also available directly at the unit it is possible for example to record a whole live concert completely without a computer. Music that was copied onto the stick earlier can be played back anytime on any outputs.

The following chapters explain features, possibilities, but also restrictions of this functionality.

36.2 Operation

In *TotalMix FX* the **Recorder** panel controls the record and playback functions. The configuration of record/playback is stored in the workspace, therefore identical in its 8 Snapshots.

File selection. Multi-purpose dialog.

Displays detailed information on current USB media conditions. No Media (no media recognized), Initializing (Medium is currently initialized), FS Error (File System Error, no FAT32), No Files (no audio files found).

In case the media contains audio material, files can be selected from the file dialog box after a click on the arrow to the right.

Clicking on the red button will initiate recording, and a new file will be created immediately, with an increment file number according to present files.



Info. Opens a dialog with information about the selected file: file name, number of channels, sample rate, length (time), free memory.

Delete. Offers direct erasure of the current file. After deletion, the media is read again (Initializing) which can take some time on larger hard drives. Deleting further files is possible even while the initialization is still in progress.

Status Panel. Displays some important data in an overview window: current position or length of the file, free memory, USB Load, Errors.

Position display. The position of the knob shows the current playback position within the file. The knob, and with it the playback position, can also be moved by dragging it with the mouse.

Transport bar. Stop, Play/Pause and Record. Two clicks on Stop cause a jump to the beginning of the file.

Record View. Switches from Mixer View to Record View. In Record View the Mute and Solo buttons in the first and third row are replaced by Play and Record (Arm) buttons.

A click on the Playback button opens a dialog to assign channels. A playback is not only possible at the outputs but also at the mixer input. This way, signals can also be processed with Echo/Reverb and mixed with any other signal to any output.

Note: The Level Meters show the playback signal only when in *Post FX* mode.



The Record buttons behave in a similar way to other buttons in TotalMix: Activation/deactivation of all channels to the right by Ctrl + mouse click, flashing buttons when the maximum number of channels has been exceeded after changing the sample rate. When loading a different workspace during ongoing recording and playback, the configuration of record and playback is not updated or changed.

On the *Fireface UFX* itself, the display shows the **Record/Playback** page automatically when a storage medium is connected and recognized, or after pushing the METERS button.

File. Name of the currently selected file.

Status. This line changes its content depending on the current operation: information on the selected file, the ongoing or just completed recording: xx channels selected (number of channels armed for recording), SR xx kHz (sample rate), USB xx%, x Err (USB Load and number of errors).

Time. Length of the recording or current playback position. When selecting the record button at the unit the medium's remaining total record time is shown. Due to the limitation to 100 files the actual recording time may be shorter.

Transport Bar. Turning encoder 2 moves the cursor over *Del* (Delete), *Stop*, *Play/Pause* and *Record*. The selected function is initiated by pressing encoder 2.

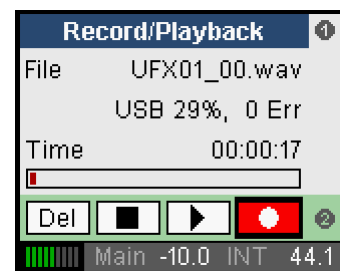
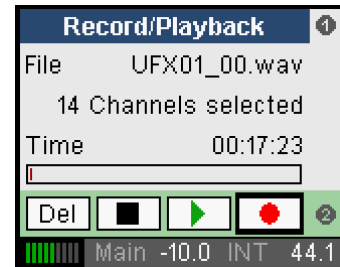

Turning encoder 1 brings up the **USB Memory** page.

Enable Rec/Play. The USB Direct Recording can be switched off completely. This reduces the DSP load a bit, which then raises the number of possible effects in TotalMix FX.

Capacity. Storage size of the media.

Free. Free space on the media.

Max R/W Time. The time needed for the read or write operation. Details see chapter 36.5.

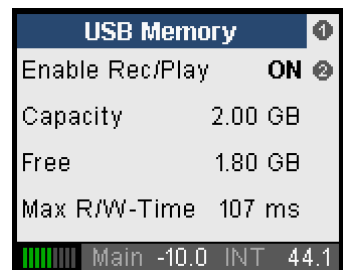

36.3 Limitations and Important Notes

The media must be formatted as FAT32, primary type. Only the first partition is used. Logical partitions are not supported.

A recording is always stopped when the sample rate changes.

Changing the record configuration (armed channels) is not possible during an ongoing recording. Channels are recorded without placeholders and without labelling, in straight ascending order. For a playback on the exact same channels, the playback channels have to be selected accordingly in TM FX or the unit.

The recording is done at the current sample rate as 24 bit WAV file. A file can be up to 2 GB in size and includes all (up to 60) channels in interleaved format. The filename is UFX01_00.wav. After reaching the 2 GB limit a new file is automatically written, with an incremental file number (UFX01_01.wav). The UFX will write up to 100 files consecutively (UFX_01_99.wav). After that, a new recording has to be started (UFX02_00.wav).

At a sample rate of 48 kHz, up to 60 channels (inputs and outputs), at 96 kHz 34 channels, at 192 kHz 16 channels can be selected. The actual number of channels that can be used error-free depends on the media, see chapter 36.5.

The playback from a storage device does not change the current sample rate. To match pitch and speed, the sample rate has to be set manually to the correct value. Playback can be assigned to multiple outputs.

The UFX can play back externally recorded WAV files, as long as these have 16 or 24 bit resolution.

The recording signal is taken before EQ and Dynamics, on both inputs and outputs. To record with EQ/Dyn, activate REC on an output and route a signal processed by the input EQ/Dyn to that output. The insert point of playback is at the same place.

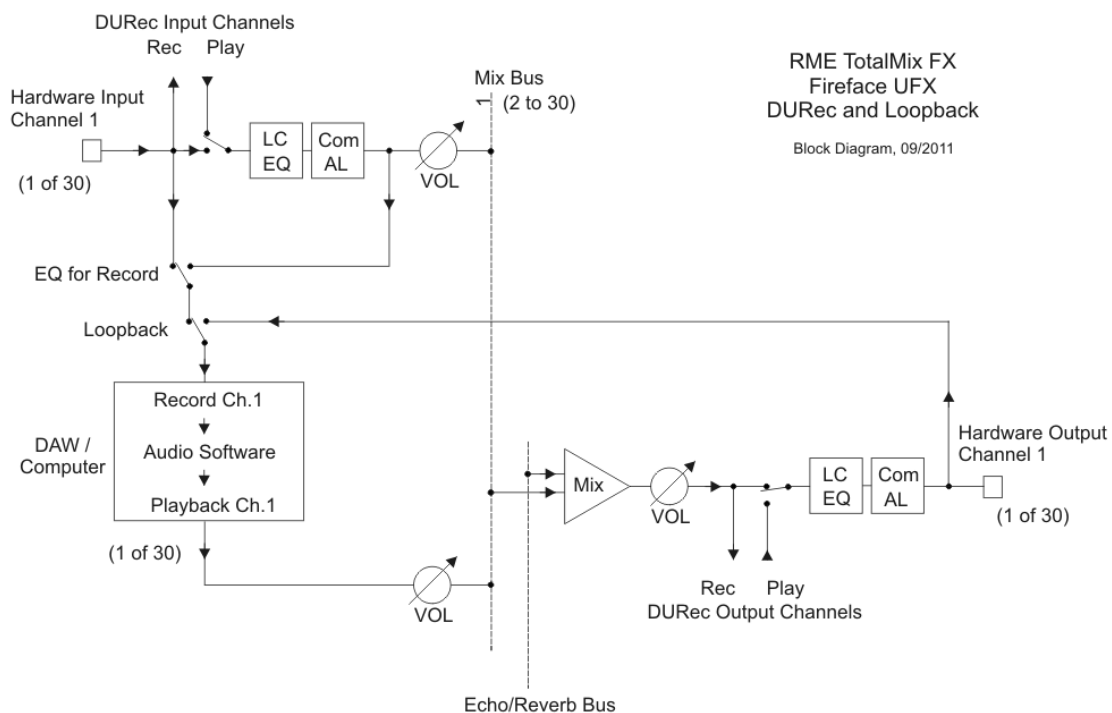

The block diagram shows the signal flow for various situations, depending on the state of *Loopback*, *EQ for Record* and *Play active*. In the diagram *Loopback* and *EQ* are switched to off, but a playback is active in the input.

Some extra notes that are worth to be pointed out again:

- The signal recorded by audio software is usually that from the input. But when the option *DSP – EQ for Record* has been activated in the Settings dialog the software receives the Play input signal – as soon as a playback is started from the USB device.
- On an output Echo/Reverb gets recorded. To add Echo/Reverb to a playback the playback must be assigned to an input.
- A playback via USB can not be processed and immediately recorded again via DURec. While the block diagram seems to present such functionality please remember that DURec can do only one thing at a time – record or playback.

36.4 Multichannel WAV File Batch Processor

To avoid any kind of performance problems the recording of all channels is done into a single multi-channel interleaved file, guaranteeing highest streaming performance with any media.

Most digital audio workstations can import such multi-channel wave files directly into their projects. Also there already exist some free tools to split those multi-channel files into standard stereo or single channel files. The need for the special RME tool arises from the fact that fully compatible wave files can not be bigger than 2 GByte. With higher track counts and longer recording times this limit is quickly exceeded. The DUREC process of the Fireface UFX therefore writes multiple consecutive files of 2 GByte each. Importing these files into typical DAWs requires the user to adjust and align the content of each file to the previous one.

RME's Multichannel WAV File Batch Processor offers the easiest way to combine and split those multichannel interleaved files into single or dual channel files. The content of consecutive files is automatically combined into a single file. In the rare case that these again exceed the 2 GB limit the tool automatically writes RF64 files. The Mac version can also write CAF (Core Audio Format) files.

The RME tool can also perform multiple conversions of different recordings. Once all the single tasks are set up the software will process them one after the other automatically.

The free software is available for Windows and Mac OS X and can be downloaded from the RME website, www.rme-audio.com, section **Downloads / Software**.

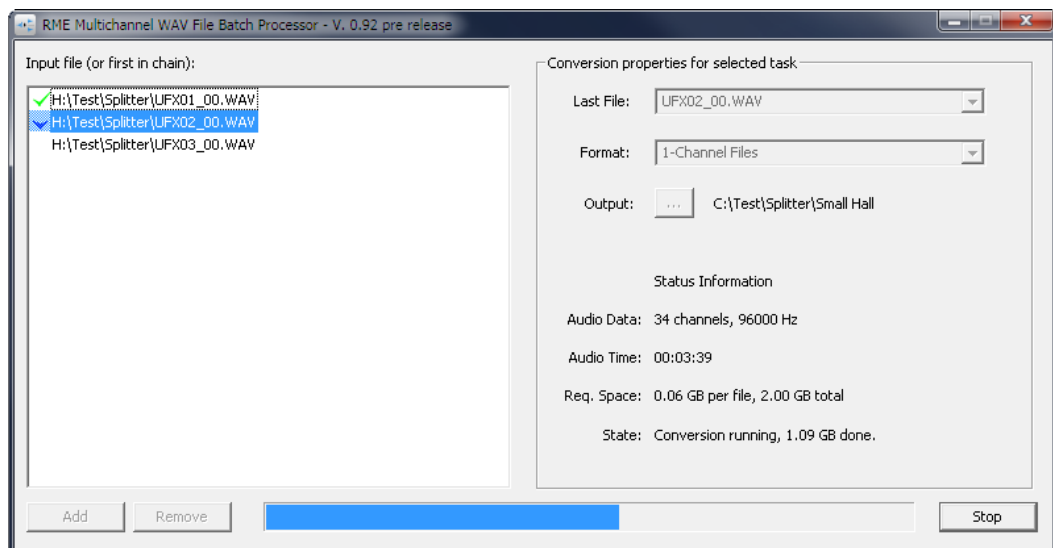

36.5 Technical Background

Compared to a usual computer, the front USB port of the UFX has a limited buffer to compensate for interruptions to the write process. Unfortunately, these occur quite often with USB sticks, and sometimes are of an astonishing duration. The effect of the buffer depends on the amount of data to be transmitted, which is the combination of sample rate and channel count. The higher the data rate, the shorter the available buffer time. When a medium causes a pause that is longer than the buffer time, data is lost.*

Information on the performance of the record media

To determine the highest record channel count of a hard drive or USB stick the UFX displays several values. On the page *Record/Playback*:

USB Load: should exceed 80% only for a short time.

Errors: Each single error means a buffer with a bigger block of samples has been lost. Although that is not always audible only a display of 0 is correct.

On the page *USB Memory*:

Max R/W Time (Read/Write Time): This constantly updated value is the quickest way to identify slow media that suffer from interruptions of the write process. Hard drives often show values in the range of 100 ms, while sticks reach up to 800 (!) ms.

Checking the performance of the record media

Every USB stick can be used for recording – but most are too slow to record more than a few channels. While write rates higher than 10 MB/s are rare, simultaneous quick processing of recorded data is even less frequently found. Therefore the toughest record situation for the UFX, a recording of 34 channels at 96 kHz, is usually only possible by using hard drives.

To determine the maximum channel count of a medium, activate all 34 channels at a sample rate of 96 kHz. This configuration causes the highest data throughput (9.79 MB/s) with the smallest internal buffer (306 ms). Most hard drives manage an error-free recording until the drive is full. In case the UFX shows errors, reduce the number of channels step by step until no errors are shown anymore.

Note: 15 channels at 192 kHz equal 30 channels at 96 kHz and 60 channels at 48 kHz (8.64 MB/s, 347 ms buffer).

A more realistic example is the recording of all 30 inputs and of two submixes (34 channels) at 48 kHz. With 4.9 MB/s data transfer and 612 ms buffer time better USB sticks will already handle the task without any problem. The display of USB Load, Max Write Time and errors quickly reveals where the limit of the particular stick lies.

Note: Playback is usually not affected by the mentioned performance problems.

*An example of a USB flash drive that handled the maximum transfer bandwidth error-free in our tests is the *SanDisk Extreme Memory*, available in 16, 32 and 64 GByte. It worked without write pausing under USB 2, and is lightning fast under USB 3 as well.

User's Guide



Fireface UFX

▶ **Technical Reference**

37. Technical Specifications

37.1 Analog

AD, Line In 1-8, rear

- Resolution AD: 24 bit
- Signal to Noise ratio (SNR): 110 dB RMS unweighted, 113 dBA
- Frequency response @ 44.1 kHz, -0.1 dB: 15 Hz – 21.5 kHz
- Frequency response @ 96 kHz, -0.5 dB: 7 Hz – 45.5 kHz
- Frequency response @ 192 kHz, -1 dB: 5 Hz – 66.5 kHz
- THD: < -110 dB, < 0.00032 %
- THD+N: < -104 dB, < 0.00063 %
- Channel separation: > 110 dB
- Maximum input level: +19 dBu
- Input: 6.3 mm TRS jack, electronically balanced
- Input impedance: 10 kOhm
- Input sensitivity switchable to Lo Gain, +4 dBu, -10 dBV
- Input level for 0 dBFS @ Lo Gain: +19 dBu
- Input level for 0 dBFS @ +4 dBu: +13 dBu
- Input level for 0 dBFS @ -10 dBV: +2 dBV

Microphone In 9-12, front

As AD, but:

- Input: XLR, electronically balanced
- Input impedance: 2 kOhm
- Signal to Noise ratio (SNR): 112 dB RMS unweighted, 115 dBA
- Gain range: 65 dB
- Maximum input level, Gain 0 dB: +12 dBu
- Maximum input level, Gain 65 dB: -53 dBu
- CLIP LED: 0 dBFS
- SIG LED: -46 dBFS

Instrument In 9-12, front

As AD, but:

- Input: 6.3 mm TS jack, unbalanced
- Input impedance: 800 kOhm
- Signal to Noise ratio (SNR): 112 dB RMS unweighted, 115 dBA
- Gain range: 55 dB
- Maximum input level, Gain 10 dB: +21 dBu
- Maximum input level, Gain 65 dB: -34 dBu

DA, Line Out 3-8, rear

- Resolution: 24 bit
- Dynamic range (DR): 115 dB RMS unweighted, 118 dBA
- Frequency response @ 44.1 kHz, -0.5 dB: 5 Hz – 22 kHz
- Frequency response @ 96 kHz, -0.5 dB: 5 Hz – 45 kHz
- Frequency response @ 192 kHz, -1 dB: 5 Hz - 80 kHz
- THD: -104 dB, < 0.00063 %
- THD+N: -100 dB, < 0.001 %
- Channel separation: > 110 dB
- Maximum output level: +19 dBu
- Output: 6.3 mm TRS jack, servo-balanced
- Output impedance: 75 Ohm
- Output level switchable Hi Gain, +4 dBu, -10 dBV
- Output level at 0 dBFS @ Hi Gain: +19 dBu
- Output level at 0 dBFS @ +4 dBu: +13 dBu
- Output level at 0 dBFS @ -10 dBV: +2 dBV

DA - Stereo Monitor Output XLR (1-2)

As DA, but:

- Output: XLR, balanced
- Output level switchable 24 dBu, Hi Gain, +4 dBu, -10 dBV
- Output level at 0 dBFS @ 24 dBu: +24 dBu
- Output level at 0 dBFS @ Hi Gain: +19 dBu
- Output level at 0 dBFS @ +4 dBu: +13 dBu
- Output level at 0 dBFS @ -10 dBV: +2 dBV

DA - Stereo Monitor Output Phones (9-12)

As DA, but:

- Output: 6.3 mm TRS stereo jack, unbalanced
- Maximum output level at 0 dBFS, High: +17 dBu
- Maximum output level at 0 dBFS, Low: +2 dBV
- Output impedance: 30 Ohm

37.2 MIDI

- 2 x MIDI I/O via 5-pin DIN jacks
- Galvanically isolated by optocoupled input
- Hi-speed mode: Jitter and response time typically below 1 ms
- Separate 128 byte FIFOs for input and output

37.3 Digital

- Clocks: Internal, ADAT In, AES In, word clock in
- Low Jitter Design: < 1 ns in PLL mode, all inputs
- Internal clock: 800 ps Jitter, Random Spread Spectrum
- Jitter suppression of external clocks: > 30 dB (2.4 kHz)
- Effective clock jitter influence on AD and DA conversion: near zero
- PLL ensures zero dropout, even at more than 100 ns jitter
- Digital Bitclock PLL for trouble-free varispeed ADAT operation
- Supported sample rates: 28 kHz up to 200 kHz

37.4 Digital Inputs

AES/EBU

- 1 x XLR, transformer-balanced, galvanically isolated, according to AES3-1992
- High-sensitivity input stage (< 0.3 Vpp)
- SPDIF compatible (IEC 60958)
- Accepts Consumer and Professional format
- Lock range: 27 kHz – 200 kHz
- Jitter when synced to input signal: < 1 ns
- Jitter suppression: > 30 dB (2.4 kHz)

ADAT Optical

- 2 x TOSLINK, format according to Alesis specification
- Standard: 2 x 8 channels 24 bit, up to 48 kHz
- Double Speed (S/MUX): 2 x 4 channels 24 bit 96 kHz
- Quad Speed (S/MUX4): 2 x 2 channels 24 bit 192 kHz
- Windows USB Quad Speed: 1 x 2 channels 24 bit 192 kHz
- Bitclock PLL ensures perfect synchronisation even in varispeed operation
- Lock range: 31.5 kHz – 50 kHz
- Jitter when synced to input signal: < 1 ns
- Jitter suppression: > 30 dB (2.4 kHz)

SPDIF optical (ADAT2)

- 1 x optical, according to IEC 60958
- Accepts Consumer and Professional format
- Lock range: 27 kHz – 200 kHz
- Jitter when synced to input signal: < 1 ns
- Jitter suppression: > 30 dB (2.4 kHz)

Word Clock

- BNC, not terminated (10 kOhm)
- Switch for internal termination 75 Ohm
- Automatic Double/Quad Speed detection and internal conversion to Single Speed
- SteadyClock guarantees super low jitter synchronization even in varispeed operation
- Not affected by DC-offsets within the network
- Signal Adaptation Circuit: signal refresh through auto-center and hysteresis
- Overvoltage protection
- Level range: 1.0 Vpp – 5.6 Vpp
- Lock Range: 27 kHz – 200 kHz
- Jitter when synced to input signal: < 1 ns
- Jitter suppression: > 30 dB (2.4 kHz)

37.5 Digital Outputs

AES/EBU

- XLR, transformer-balanced, galvanically isolated, according to AES3-1992
- Output level Professional 4.5 Vpp, Consumer 2.6 Vpp
- Format Professional according to AES3-1992 Amendment 4
- Format Consumer (SPDIF) according to IEC 60958
- Single Wire mode, sample rate 28 kHz up to 200 kHz

ADAT

- 2 x TOSLINK
- Standard: 2 x 8 channels 24 bit, up to 48 kHz
- Double Speed (S/MUX): 2 x 4 channels 24 bit 96 kHz
- Quad Speed (S/MUX4): 2 x 2 channels 24 bit 192 kHz
- Windows USB Quad Speed: 1 x 2 channels 24 bit 192 kHz

SPDIF optical (ADAT2)

- Format Consumer (SPDIF) according to IEC 60958
- Sample rate 28 kHz up to 200 kHz

Word Clock

- BNC
- Max. output voltage: 5 Vpp
- Output voltage @ 75 Ohm termination: 4.0 Vpp
- Output impedance: 10 Ohm
- Frequency range: 27 kHz – 200 kHz

37.6 General

- Power supply: Internal switching PSU, 100 - 240 V AC, 30 Watt
- Typical power consumption: 22 Watt
- Dimensions including rack ears (WxHxD): 483 x 44 x 242 mm (19" x 1.73" x 9.5")
- Dimensions without rack ears/handles (WxHxD): 436 x 44 x 235 mm (17.2" x 1.73" x 9.3")
- Weight: 3 kg (6.6 lbs)
- Temperature range: +5° up to +50° Celsius (41° F up to 122°F)
- Relative humidity: < 75%, non condensing

38. Technical Background

38.1 Lock and SyncCheck

Digital signals consist of a carrier and the data. If a digital signal is applied to an input, the receiver has to synchronize to the carrier clock in order to read the data correctly. To achieve this, the receiver uses a PLL (Phase Locked Loop). As soon as the receiver meets the exact frequency of the incoming signal, it is locked. This **Lock** state remains even with small changes of the frequency, because the PLL tracks the receiver's frequency.

If an ADAT or SPDIF signal is applied to the Fireface UFX, the corresponding input LED starts flashing. The unit indicates LOCK, i. e. a valid input signal (in case the signal is also in sync, the LED is constantly lit, see below).

Unfortunately, LOCK does not necessarily mean that the received signal is correct with respect to the clock which processes the read out of the embedded data. Example [1]: The Fireface is set to 44.1 kHz internally (clock mode Master), and a mixing desk with ADAT output is connected to input ADAT1. The corresponding LED will show LOCK immediately, but usually the mixing desk's sample rate is generated internally (also Master), and thus slightly higher or lower than the Fireface's internal sample rate. Result: When reading out the data, there will frequently be read errors that cause clicks and drop outs.

Also when using multiple inputs, a simple LOCK is not sufficient. The above described problem can be solved elegantly by setting the Fireface from Master to AutoSync (its internal clock will then be the clock delivered by the mixing desk). But in case another, un-synchronous device is connected, there will again be a slight difference in the sample rate, and therefore clicks and drop outs.

In order to display those problems optically at the device, the Fireface includes **SyncCheck**. It checks all clocks used for *synchronicity*. If they are not synchronous to each other (i. e. absolutely identical), the SYNC LED of the asynchronous input flashes. In case they are completely synchronous, all LEDs are constantly lit. In example 1 it would have been obvious that the LED ADAT 1 kept on flashing after connecting the mixing desk.

In practice, SyncCheck allows for a quick overview of the correct configuration of all digital devices. So one of the most difficult and error-prone topics of the digital studio world finally becomes easy to handle.

The same information is presented in the Fireface's Settings dialog. In the status display *Sync-Check* the state of all clocks is decoded and shown as simple text (No Lock, Lock, Sync).

38.2 Latency and Monitoring

The term **Zero Latency Monitoring** has been introduced by RME in 1998 for the DIGI96 series of audio cards. It stands for the ability to pass-through the computer's input signal at the interface directly to the output. Since then, the idea behind has become one of the most important features of modern hard disk recording. In the year 2000, RME published two ground-breaking Tech Infos on the topics *Low Latency Background*, which are still up-to-date: *Monitoring*, *ZLM and ASIO*, and *Buffer and Latency Jitter*, both found on the RME website.

How much Zero is Zero?

From a technical view there is no zero. Even the analog pass-through is subject to phase errors, equalling a delay between input and output. However, delays below certain values can subjectively be claimed to be a zero-latency. This applies to analog routing and mixing, and in our opinion also to RME's Zero Latency Monitoring. The term describes the digital path of the audio data from the input of the interface to its output. The digital receiver of the Fireface UFX can't operate un-buffered, and together with TotalMix and the output via the transmitter, it causes a typical delay of 3 samples. At 44.1 kHz this equals about 68 μ s (0.000068 s), at 192 kHz only 15 μ s. The delay is valid for ADAT and SPDIF in the same way.

Oversampling

While the delays of digital interfaces can be disregarded altogether, the analog inputs and outputs do cause a significant delay. Modern converter chips operate with 64 or 128 times oversampling plus digital filtering, in order to move the error-prone analog filters away from the audible frequency range as far as possible. This typically generates a delay of one millisecond. A playback and re-record of the same signal via DA and AD (loopback) then causes an offset of the newly recorded track of about 2 ms.

Low Latency!

The Fireface UFX uses AD converters from Cirrus Logic with an innovative digital filter, achieving for the first time a delay of only 12 samples in Single Speed, 9 samples in Double Speed, and 5 (!) samples in Quad Speed. The DA converter from Texas Instruments also has a low delay value compared to other converters. The exact delays of the Fireface UFX are:

Sample frequency kHz	44.1	48	88.2	96	176.4	192
AD (12 x 1/fs) ms	0.27	0.25				
AD (9 x 1/fs) ms			0.1	0.09		
AD (5 x 1/fs) ms					0.028	0.026
DA (28 x 1/fs) ms	0.63	0.58	0.32	0.29	0.16	0.15

Buffer Size (Latency)

Windows: This option found in the Settings dialog defines the size of the buffers for the audio data used in ASIO and WDM (see chapter 9).

Mac OS X: The buffer size is defined within the application. Only some do not offer any setting. For example iTunes is fixed to 512 samples.

General: A setting of 64 samples at 44.1 kHz causes a latency of 1.5 ms, for record and playback each. But when performing a digital loopback test no latency/offset can be detected. The reason is that the software naturally knows the size of the buffers, therefore is able to position the newly recorded data at a place equalling a latency-free system.

AD/DA Offset under ASIO and OS X: ASIO (Windows) and Core Audio (Mac OS X) allow for the signalling of an offset value to correct buffer independent delays, like AD- and DA-conversion or the Safety Buffer described below. An analog loopback test will then show no offset, because the application shifts the recorded data accordingly. Because in real world operation analog record and playback is unavoidable, the drivers include an offset value matching the Fireface's converter delays.

Therefore, in a **digital** loopback test a *negative* offset of about 3 ms occurs. This is no real problem, because this way of working is more than seldom, and usually the offset can be compensated manually within the application. Additionally, keep in mind that even when using the digital I/Os usually at some place an AD- and DA-conversion is involved (no sound without...).

Note: Cubase and Nuendo display the latency values signalled from the driver separately for record and playback. The values do not exactly equal the buffer size (for example 3 ms at 128 samples), instead a higher value is shown, including the time needed for the AD/DA-conversion. Playback shows an even higher value – see Safety Buffer.

Safety Buffer

An additional small safety buffer on the playback side has proven to be very efficient and useful. It is therefore implemented in all RME interfaces. Under Windows the Fireface UFX uses a fixed additional buffer of 32 samples with USB and 64 samples with FireWire, under Mac 32 samples, which is added to the current buffer size. The main advantage is the ability to use lowest latency at highest CPU loads. Furthermore, the fixed buffer does not add to the latency jitter (see Tech Info), the subjective timing is extraordinary.

Core Audio's Safety Offset

Under OS X, every audio interface has to use a so called *Safety Offset* on record and playback, otherwise Core Audio won't operate click-free. The Fireface uses a Safety Offset of 16 samples with USB and 32 samples with FireWire. This offset is signalled to the system, and the software can calculate and display the total latency of buffer size plus AD/DA offset plus 2 x Safety Offset plus Safety Buffer for the current sample rate.

38.3 USB Audio

USB audio is in several ways different from PCI based audio interfaces.

A Fireface can achieve a performance similar to a PCI or PCI Express card when used with an optimal PC. Low CPU load and click-free operation even at 48 samples buffer size are indeed possible on current computers. However, using older computers a simple stereo playback will begin to cause a CPU load of more than 30%.

A computer blocked for a short time – no matter if ASIO or WDM – will lose one or more data packets. Such problems can only be solved by increasing the buffer size (and with this the latency).

The Fireface features a unique data checking, detecting errors during transmission via USB and displaying them in the Settings dialog.

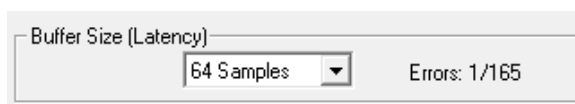

Additionally the Fireface provides a special mechanism to continue recording and playback in case of drop-outs, and to correct the sample position in real-time.

Like any audio interface the Fireface should have a data transmission to the computer as undisturbed as possible. The easiest way to guarantee this is to connect it to its own bus, which should be no big problem as most USB 2.0 interfaces are a double bus design. A check in the Device Manager can be done as follows:

- Connect the Fireface to a USB port
- Start the Device Manager, View set to Devices by Connection
- Select ACPI x86-based PC, Microsoft ACPI-Compliant System, expand PCI Bus

This branch normally includes two entries of a *USB2 Enhanced Host Controller*. A USB Root Hub can be seen, which then connects all USB devices, including the Fireface. By reconnecting to a different port this view immediately shows at which of the two controllers the Fireface is connected. With multiple devices it can also be checked if they are connected to the same controller.

Furthermore this information can be used to operate an external USB drive without disturbing the Fireface, by simply connecting the drive to the other controller.

Especially with notebooks it can happen that all internal devices and all the sockets/ports are connected to the same controller, with the second controller not used at all. In that case all devices have to use the same bus and interfere with each other.

38.4 FireWire Audio

FireWire audio is in several ways different from PCI audio interfaces. RME's PCI data transmission happens per channel, while FireWire is working interleaved. A direct communication with the application (Zero CPU load) is not possible with FireWire, because communication has to be established by the operating system's FireWire driver. Compared to PCI cards, the FireWire subsystem creates an additional CPU load at lower latencies.

Due to insufficient buffering within FireWire controllers, single peak loads on the PCI bus can already cause loss of one or more data packets. This is independent of the manufacturer and no RME problem.

FireWire Audio does not reach the same performance as PCI audio. On a standard computer with modern single PCI bus, about 100 audio channels can be transmitted per direction (record/playback). Exceeding this limit, any system activity - even outside the PCI bus - causes drop outs.

The Fireface UFX features a unique data checking, detecting errors during transmission via PCI/FireWire and displaying them in the Settings dialog.

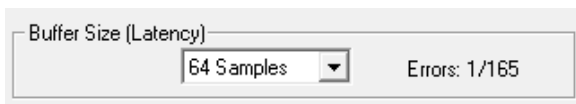

Additionally the Fireface provides a special mechanism which allows to continue record and playback in spite of drop-outs, and to correct the sample position in real-time. Detailed information on this topic can be found in the Tech Info *FireWire Audio by RME – Technical Background* on the RME website: http://www.rme-audio.com/english/techinfo/fwaudio_rme.htm

Transferring these experiences to FireWire and the Fireface UFX means that besides the number of channels the *bus load* has to be taken into account too. One channel at 96 kHz causes the same load to the system as two channels at 48 kHz, the bus load is doubled at 96 kHz and quadrupled at 192 kHz. *Limit Bandwidth* sets a constant number of channels, but those channels cause a bigger load in DS and QS mode, because more data have to be transferred. For example the 18 channels at 192 kHz equal a FireWire and PCI bus load of 72 channels at 48 kHz:

Limit Bandwidth	48 kHz (max 30)	DS (max. 22)	QS (max. 18)
All Channels	30	44	72
An.+AES+ADAT1	22	40	64
Analog+AES	14	28	56
Analog 1-8	8	16	32

To use FireWire as efficiently as possible, the Fireface allows to reduce the number of transferred channels. *Limit Bandwidth* provides four options, limiting the transmission internally to 30, 22, 14 or 8 channels. This limitation is independent from the sample rate. As can be seen in the following table, in 96/162 kHz mode there is no difference between the setting *All Channels* and *An.+AES+ADAT1* as the Fireface UFX offers only 18 channels in Quad Speed mode anyway.

Limit Bandwidth	48 kHz (30)	96 kHz (22)	192 kHz (18)	FW-Channels
All Channels	x	/	/	30
An.+AES+ADAT1	x	x	/	22
Analog+AES	x	x	x	14
Analog 1-8	x	x	x	8

38.5 DS - Double Speed

When activating the *Double Speed* mode the Fireface UFX operates at double sample rate. The internal clock 44.1 kHz turns to 88.2 kHz, 48 kHz to 96 kHz. The internal resolution is still 24 bit.

Sample rates above 48 kHz were not always taken for granted, and are still not widely used because of the CD format (44.1 kHz) dominating everything. Before 1998 there were no receiver/transmitter circuits available that could receive or transmit more than 48 kHz. Therefore a work-around was used: instead of two channels, one AES line only carries one channel, whose odd and even samples are being distributed to the former left and right channels. By this, you get the double amount of data, i. e. also double sample rate. Of course in order to transmit a stereo signal two AES/EBU ports are necessary then.

This transmission mode is called *Double Wire* in the professional studio world, and is also known as *S/MUX (Sample Multiplexing)* in connection with the ADAT format.

Because the ADAT interface does not allow for sampling frequencies above 48 kHz (a limitation of the interface hardware), the Fireface UFX automatically uses *Sample Multiplexing* in DS mode. One channel's data is distributed to two channels according to the following table:

Analog In	1	2	3	4	5	6	7	8
DS Signal Port	1/2 ADAT1	3/4 ADAT1	5/6 ADAT1	7/8 ADAT1	1/2 ADAT2	3/4 ADAT2	5/6 ADAT2	7/8 ADAT2

As the transmission of double rate signals is done at standard sample rate (Single Speed), the ADAT outputs still deliver 44.1 kHz or 48 kHz.

38.6 QS – Quad Speed

Due to the small number of available devices that use sample rates up to 192 kHz, but even more due to a missing real world application (CD...), Quad Speed has had no broad success so far. An implementation of the ADAT format as double S/MUX results in only two channels per optical output.

In Quad Speed mode the Fireface UFX automatically uses *Sample Multiplexing*. One channel's data is distributed to four channels according to the following table:

Analog In	1	2	3	4	5	6	7	8
QS Signal Port	1/2/3/4 ADAT1	5/6/7/8 ADAT1	1/2/3/4 ADAT2	5/6/7/8 ADAT2	-	-	-	-

As the transmission of quad rate signals is done at standard sample rate (Single Speed), the ADAT output still delivers 44.1 kHz or 48 kHz.

38.7 Noise level in DS / QS Mode

The outstanding signal to noise ratio of the Fireface UFX AD-converters can be verified even without expensive test equipment, by using record level meters of various software. But when activating the DS and QS mode, the displayed noise level will rise from -109 dB to -104 dB at 96 kHz, and -82 dB at 192 kHz. This is not a failure. The software measures the noise of the whole frequency range, at 96 kHz from 0 Hz to 48 kHz (RMS unweighted), at 192 kHz from 0 Hz to 96 kHz.

When limiting the measurement range from 20 Hz to 20 kHz (so called audio bandpass) the value would be -109 dB again. This can be verified with RME's *DIGICheck*. The function **Bit Statistic & Noise** measures the noise floor by *Limited Bandwidth*, ignoring DC and ultrasound.

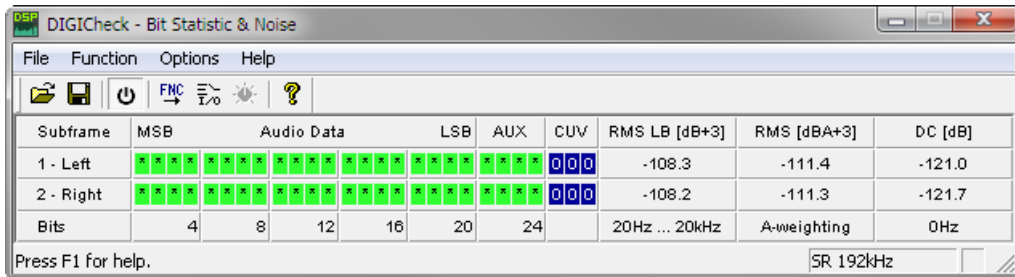

The reason for this behaviour is the noise shaping technology of the analog to digital converters. They move all noise and distortion to the in-audible higher frequency range, above 24 kHz. That's how they achieve their outstanding performance and sonic clarity. Therefore the noise is slightly increased in the ultrasound area. High-frequent noise has a high energy. Add the doubled (quadrupled) bandwidth, and a wideband measurement will show a significant drop in SNR, while the human ear will notice absolutely no change in the audible noise floor.

38.8 SteadyClock

The SteadyClock technology of the Fireface UFX guarantees an excellent performance in all clock modes. Thanks to a highly efficient jitter suppression, the AD- and DA-conversion always operates on highest sonic level, being completely independent from the quality of the incoming clock signal.

SteadyClock has been originally developed to gain a stable and clean clock from the heavily jittery MADI data signal (the embedded MADI clock suffers from about 80 ns jitter). Using the Fireface's input signals AES and ADAT, you'll most probably never experience such high jitter values. But SteadyClock is not only ready for them, it would handle them just on the fly.

Common interface jitter values in real world applications are below 10 ns, a very good value is less than 2 ns.

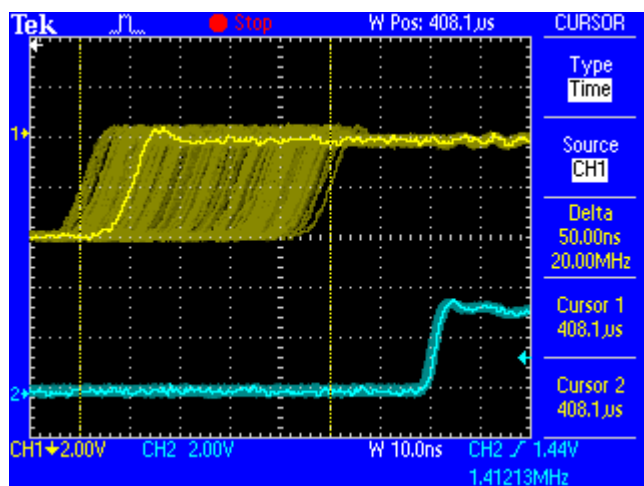

The screenshot shows an extremely jittery SPDIF signal of about 50 ns jitter (top graph, yellow). SteadyClock turns this signal into a clock with less than 2 ns jitter (lower graph, blue). The signal processed by SteadyClock is of course not only used internally, but also used to clock the digital outputs. Therefore the refreshed and jitter-cleaned signal can be used as reference clock without hesitation.

39. Diagrams

39.1 Block Diagram Fireface UFX

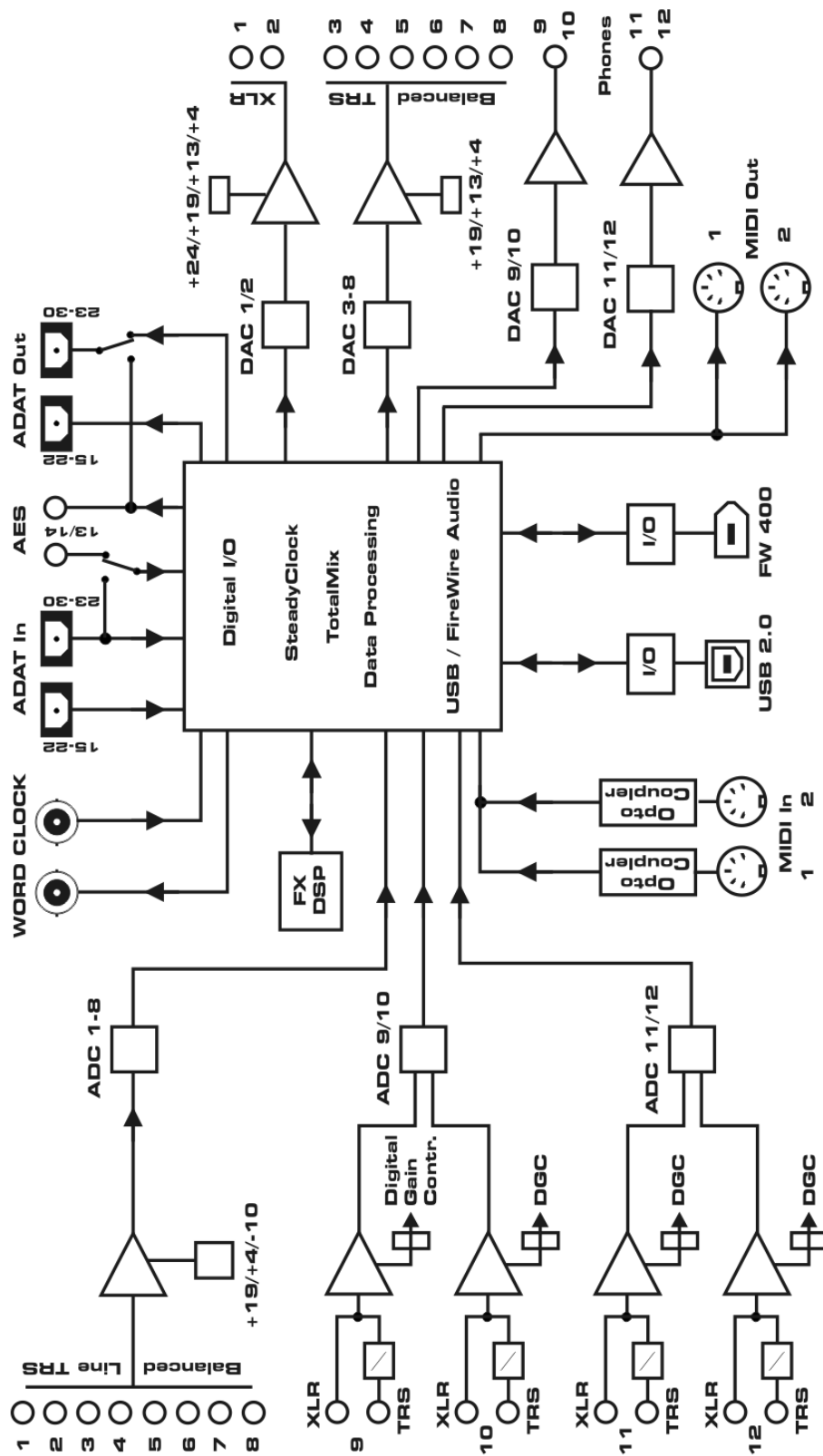

39.2 Connector Pinouts

TRS jacks of analog input / output

The stereo 1/4" TRS jacks of the analog inputs and outputs are wired according to international standards:

Tip = + (hot)
Ring = - (cold)
Sleeve = GND

The servo balanced input and output circuitry allows to use monaural TS jacks (unbalanced) with no loss in level. This is the same as when using a TRS-jack with ring connected to ground.

XLR jacks of analog inputs

The XLR jacks are wired according to international standards:

1 = GND (shield)
2 = + (hot)
3 = - (cold)

TRS Phones jack

The analog monitor outputs on the front are accessible through stereo 1/4" TRS jacks. This allows a direct connection of headphones. In case the output should operate as Line output, an adapter TRS plug to RCA phono plugs, or TRS plug to TS plugs is required.

The pin assignment follows international standards. The left channel is connected to the tip, the right channel to the ring of the TRS jack/plug.

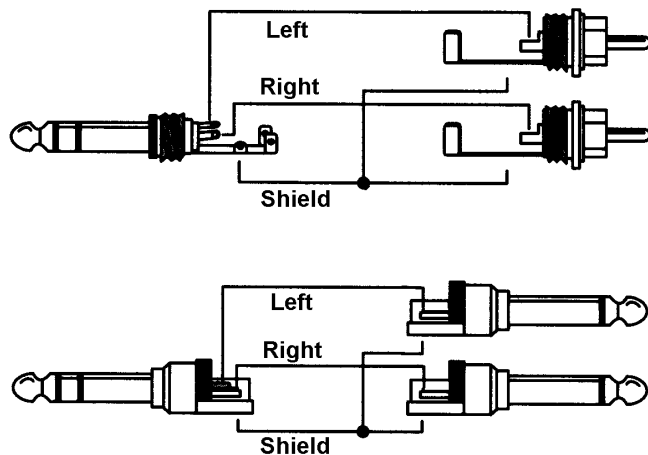



User's Guide



Fireface UFX

▶ **Miscellaneous**

40. Accessories

RME offers several optional components for the Fireface UFX:

Part Number	Description
-------------	-------------

Standard FireWire 400 cable, both sides 6-pin male:

FWK660100BL	FireWire cable IEEE1394a 6M/6M, 1 m (3.3 ft)
FWK660300BL	FireWire cable IEEE1394a 6M/6M, 3 m (9.9 ft)
FWK660400BL	FireWire cable IEEE1394a 6M/6M, 4 m (13 ft)

FireWire 400 cable, 4-pin male to 6-pin male (4-pin sockets are found on most laptops):

FWK460100BL	FireWire cable IEEE1394a 4M/6M, 1 m (3.3 ft)
FWK460300BL	FireWire cable IEEE1394a 4M/6M, 3 m (9.9 ft)
FWK460400BL	FireWire cable IEEE1394a 4M/6M, 4 m (13 ft)

Note: Cable longer than 15 ft (4.5m) is not specified for FireWire.

Optical cable with TOSLINK connectors:

OK0100PRO	Optical cable, TOSLINK, 1 m (3.3 ft)
OK0200PRO	Optical cable, TOSLINK, 2 m (6.6 ft)
OK0300PRO	Optical cable, TOSLINK, 3 m (9.9 ft)
OK0500PRO	Optical cable, TOSLINK, 5 m (16.4 ft)
OK1000PRO	Optical cable, TOSLINK, 10 m (33 ft)

ADI8-RC Standard Remote control for ADI-8 QS, UFX and UCX

41. Warranty

Each individual Fireface UFX undergoes comprehensive quality control and a complete test at IMM before shipping. The usage of high grade components should guarantee a long and trouble-free operation of the unit.

If you suspect that your product is faulty, please contact your local retailer.

Audio AG grants a limited manufacturer warranty of 6 months from the day of invoice showing the date of sale. The length of the warranty period is different per country. Please contact your local distributor for extended warranty information and service. Note that each country may have regional specific warranty implications.

In any case warranty does not cover damage caused by improper installation or maltreatment - replacement or repair in such cases can only be carried out at the owner's expense.

No warranty service is provided when the product is not returned to the local distributor in the region where the product had been originally shipped.

Audio AG does not accept claims for damages of any kind, especially consequential damage. Liability is limited to the value of the Fireface UFX. The general terms of business drawn up by Audio AG apply at all times.

42. Appendix

RME news, driver updates and further product information are available on our website:

<http://www.rme-audio.com>

Distributor: Audio AG, Am Pfanderling 60, D-85778 Haimhausen, Tel.: (49) 08133 / 918170

Manufacturer:

IMM Elektronik GmbH, Leipziger Strasse 32, D-09648 Mittweida

Trademarks

All trademarks, registered or otherwise, are the property of their respective owners. RME, DIGICheck and Hammerfall are registered trademarks of RME Intelligent Audio Solutions. DIGI96, SyncAlign, ZLM, SyncCheck, TMS, TotalMix and Fireface are trademarks of RME Intelligent Audio Solutions. Alesis and ADAT are registered trademarks of Alesis Corp. ADAT optical is a trademark of Alesis Corp. Microsoft, Windows, Windows XP, Windows Vista and Windows 7 are registered trademarks or trademarks of Microsoft Corp. Steinberg, Cubase and VST are registered trademarks of Steinberg Media Technologies GmbH. ASIO is a trademark of Steinberg Media Technologies GmbH. iPhone, iPad, iOS, Mac OS. FireWire, the FireWire symbol and the FireWire logo are trademarks of Apple Computer, Inc.

Copyright © Matthias Carstens, 03/2016. Version 2.4

Current driver and Firmware versions

USB: Windows 1.090, Mac OS X: 2.17, Firmware 357, CC 28

FireWire: Windows 3.116, Mac OS X: 3.29, Firmware 344

DSP: Firmware 161. TotalMix FX: 1.21

Although the contents of this User's Guide have been thoroughly checked for errors, RME can not guarantee that it is correct throughout. RME does not accept responsibility for any misleading or incorrect information within this guide. Lending or copying any part of the guide or the RME Driver CD, or any commercial exploitation of these media without express written permission from RME Intelligent Audio Solutions is prohibited. RME reserves the right to change specifications at any time without notice.

43. CE / FCC Compliance

CE

This device has been tested and found to comply with the limits of the European Council Directive on the approximation of the laws of the member states relating to electromagnetic compatibility according to RL2004/108/EG, and European Low Voltage Directive RL2006/95/EG.

FCC

This device complies with Part 15 of the FCC Rules. Operation is subject to the following two conditions: (1) This device may not cause harmful interference, and (2) This device must accept any interference received, including interference that may cause undesired operation.

Warning: Changes or modifications to this unit not expressly approved by the party responsible for compliance could void the user's authority to operate the equipment.

Responsible Party in USA:

Synthax United States, 6600 NW 16th Street, Suite 10, Ft Lauderdale, FL 33313
T.:754.206.4220

Trade Name: RME, Model Number: Fireplace UFX

This equipment has been tested and found to comply with the limits for a Class B digital device, pursuant to Part 15 of the FCC Rules. These limits are designed to provide reasonable protection against harmful interference in a residential installation. This equipment generates, uses, and can radiate radio frequency energy and, if not installed and used in accordance with the instructions, may cause harmful interference to radio communications. However, there is no guarantee that interference will not occur in a particular installation. If this equipment does cause harmful interference to radio or television reception, which can be determined by turning the equipment off and on, the user is encouraged to try to correct the interference by one or more of the following measures:

- Reorient or relocate the receiving antenna.
- Increase the separation between the equipment and receiver.
- Connect the equipment into an outlet on a circuit different from that to which the receiver is connected.
- Consult the dealer or an experienced radio/TV technician for help.

RoHS

This product has been soldered lead-free and fulfils the requirements of the RoHS directive.

Note on Disposal

According to the guide line RL2002/96/EG (WEEE – Directive on Waste Electrical and Electronic Equipment), valid for all european countries, this product has to be recycled at the end of its lifetime.

In case a disposal of electronic waste is not possible, the recycling can also be done by IMM Elektronik GmbH, the manufacturer of the Fireplace UFX.

For this the device has to be sent **free to the door** to:

IMM Elektronik GmbH
Leipziger Straße 32
D-09648 Mittweida
Germany



Shipments not prepaid will be rejected and returned on the original sender's costs.